

General information

Thank you for purchasing this Sens4 product. This quick start guide contains important safety information and we encourage you to read this guide prior to installation and use of this product.

Symbols used

The following symbols are used in the quick start guide:

WARNING! Critical information to prevent dangerous situations that can result in serious injury or death.

CAUTION! Important information to prevent dangerous situations that can damage the device or auxiliary equipment.

ACTION! Requires action or attention.

INFORMATION: Important recommendations and information for efficient use and best practice.

Intended use

The VPM-15 TriCAP™ transducer is intended for vacuum gas pressure measurement and control within the limits listed in the specifications.

The device complies to EMC (Electro Magnetic Compatibility) class B immunity requirements for industrial environments.

Export control (ECCN: 2B230 Dual-use product)

The TriCAP™ transducer is categorized as a Dual-use product and is subject to EU and/or Danish trade and transfer laws and restrictions. In the event that the product is exported, transferred or in any way distributed to another country or territory than delivered to by Sens4, the recipient and/or customer is responsible for compliance to export restrictions, regulations or applicable law of Denmark, local law and/or the law of the European Union.

Safety information

This product should be installed and operated by technically skilled or trained personnel only.

WARNING! This product is not intended for installation and use in the presence of flammable gases or in other explosive environments.

WARNING! Ensure that the gases exposed to the wetted materials are compatible with the wetted materials described in the specifications table and the used sealing materials.

WARNING! The pressure rating of the sensor element, connecting process fittings and sealing must comply with the maximum possible pressure in the application. The CE marking on the device does not apply to the pressure equipment directive.

WARNING! Ensure that the process connection is installed and tightened according to the recommended torque specification. Ensure that there are no leaks from the process connection when installing the transducer. Do not remove the transducer from the installation when the installation is either pressurized, evacuated, or contains hazardous fluids.

Mechanical installation

The transducer is available with KF vacuum flanges or screw-in fittings. When handling vacuum fittings always use gloves.

Refer to maximum allowed pressure, sealing method and assembly practices for the used fittings.

CAUTION! Vibrations can impact the capacitance diaphragm sensor measurement stability and accuracy. Avoid to install the unit where it's exposed to vibrations.

KF fittings installation

1. Ensure that the centering ring O-ring and its sealing surfaces are clean and free of scratches and other damages.
2. Mount the supporting KF clamp.

Configuration and programming

The VPM-15 can be user-configured, programmed and adjusted using the S4-Connect™ or RS-232/RS-485 digital interface. An optional USB programmer is available for programming the digital core of the transducer.

Partnumber	Description
PRG-RS2-15DS-01	RS-232 to USB, 15p D-sub, USB powered
PRG-RS4-15DS-01	RS-485 to USB, 15p D-sub, USB powered
PRG-WPRS2-15DS-01	RS-232 to USB, 15p D-sub, 90-230VAC
PRG-WPRS4-15DS-01	RS-485 to USB, 15p D-sub, 90-230VAC



Electrical installation

The VPM-15 requires an external power supply supplying a voltage in the range from 12 to 30 VDC. The external power supply shall be with safe isolation according to PELV (Protective Extra Low Voltage) requirements of EN60204-1.

The transducer is protected against momentary overvoltage on the supply line. The internal 100 mA thermal fuse will limit current draw in case of overvoltage to limit overheating. Additionally, the transducer is protected against reverse polarity caused by incorrect wiring to the power supply.

The transducer electronics have a high level of immunity against external electromagnetic interference. Braided shielded cables are required to comply with the immunity requirements according to EN61326-1 for industrial locations.

Electrical connection (9 pin D-sub and 15 pin D-sub)

The VPM-15 TriCAP™ transducer provides a voltage signal proportional to the measured pressure.

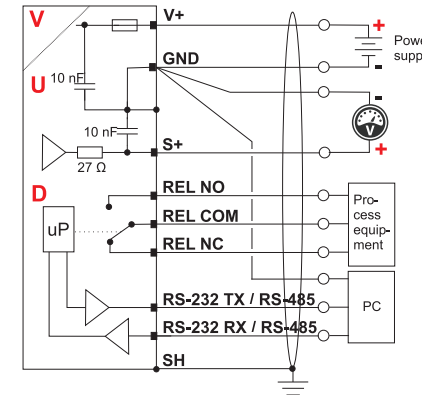

INFORMATION:

It is recommended to use a differential input to measure the output signal that uses a separate signal return wire connected to the transmitter connector. If the power supply return and signal return share the same wire connection the voltage drop as a function of the supply current will cause a measurement deviation. In that case, the measurement deviation will increase with the cable length.

Connector pinout and cable wiring

15 Pin HD D-sub RS-232 / RS-485

Pin	Description
1	RS-232 Transmit / RS-485 (-)
2	RS-232 Receive / RS-485 (+)
3	Supply voltage + (12-30 VDC)
4	Supply voltage – (return)
5	Analog voltage signal +
6	Analog voltage signal – (return)
7	Relay 1 NO ⁽¹⁾
8	Relay 1 Common ⁽²⁾
9	Relay 1 NC ⁽³⁾
10	Relay 2 NC ⁽³⁾
11	Relay 2 Common ⁽²⁾
12	Relay 2 NO ⁽¹⁾
13	Relay 3 NC ⁽³⁾ or Analog out 2 ⁽⁴⁾
14	Relay 3 Common ⁽²⁾
15	Relay 3 NO ⁽¹⁾

- (1) Optional relay - normally open contact
- (2) Optional relay - common contact
- (3) Optional relay - normally closed contact
- (4) Optional secondary analog output

The solid-state relay is a hardware option that needs to be specified when ordering the part. The setpoint value can be programmed using the S4-Connect™ or RS-232/RS-485 digital interface. For programming of setpoint values refer to the full operating and installation manual.

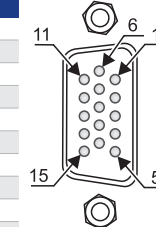

Warranty and disclaimer

Sens4 warrants this product to be free from defects in materials and workmanship for a period of 24 months from the date of the delivery.

Warranty does not cover:

1. Mechanical or corrosive damage to the sensor diaphragm
2. Physical or deposition contamination of the sensor diaphragm
3. Damage caused by shipping
4. Normal wear and tear
5. Incorrect use or installation
6. Operation beyond the published design limits

Sens4 is not liable for any claims arising from improper use, incorrect installation or use with gases or liquids not compatible with the media wetted materials described in the specifications table. Sens4 is not liable for loss of profits or revenue, overheads, loss of data, reinstallation costs, damage to other equipment or any incidental or consequential damages of any nature.

The Standard Terms and Conditions can be found on the Sens4 website at www.sens4.com and shall apply to the sales contract and use of this product.

Sens4 A/S | Ndr. Strandvej 119G | 3150 Hellebaek | Denmark
Tel: +45 8844 7044 | Email: info@sens4.com
www.sens4.com



VPM-15

TriCAP™ Vacuum Transducer

MEMS-Pirani, Piezo diaphragm and Capacitance diaphragm sensor

QSG-VPM-15-01, Revision: C, January 2023



Quick start guide

Our passion | Your value™



9 Pin D-sub RS-232 / RS-485

Pin	Description
1	Relay NO ⁽⁴⁾
2	Relay NC ⁽⁶⁾
3	Supply voltage + (12-30 VDC)
4	Supply voltage – (return)
5	Analog voltage signal +
6	Relay Common ⁽⁵⁾
7	RS-232 Transmit / RS-485 (-)
8	Analog voltage signal – (return)
9	RS-232 Receive / RS-485 (+)

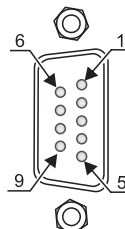

- (4) Optional relay - normally open contact
- (5) Optional relay - common contact
- (6) Optional relay - normally closed contact

The solid-state relay is a hardware option that needs to be specified when ordering the part. The setpoint value can be programmed using the S4-Connect™ or RS-232/RS-485 digital interface. For programming of setpoint values refer to the Operating manual.

6 Pin Hirschmann GO6

Pin	Description
1	Identification resistor (3K)
2	Analog voltage signal +
3	Analog voltage signal – (return)
4	Supply voltage + (12-30 VDC)
5	Supply voltage – (return)
6	Chassis

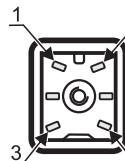

8 Pin RJ45/8P8C

Pin	Description
1	Supply voltage + (12-30 VDC)
2	Supply voltage – (return)
3	Analog voltage signal +
4	Identification resistor ⁽⁷⁾
5	Analog voltage signal – (return)
6	Relay 2 NO ⁽⁸⁾
7	Relay 1 NO ⁽⁸⁾
8	Relay 1 & 2 Common ⁽⁹⁾

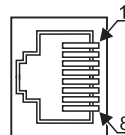

- (7) For ID resistor values refer to installation and operating manual.
- (8) Optional relay - normally open contact
- (9) Optional relay - common contact

The solid-state relay is a hardware option that needs to be specified when ordering the part. The setpoint value can be programmed using the S4-Connect™ digital interface. For programming of setpoint values refer to the Operating manual.

Signal to pressure conversion (0-10 VDC voltage output)

The transducer can provide a voltage output from 0 to 10 VDC and is available with different pre-configured output scaling.

When the transducer is configured for 1.0 VDC/decade output, the voltage signal, u , can be converted to pressure using the following expression:

$$\text{Voltage to pressure conversion: } P(u) = 10^{(u-6.5)}$$

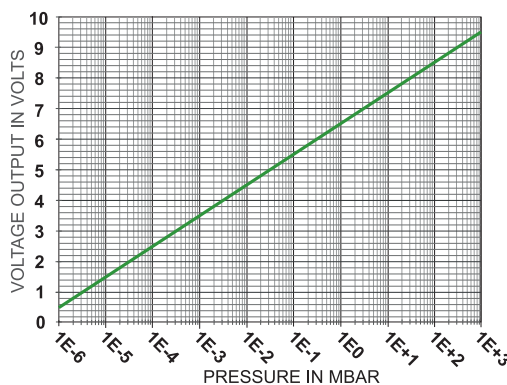

INFORMATION: Refer to Operating & Installation manual for conversion and scaling of other analog outputs. The transducer may be configured with other analog scaling than the standard 1.0 VDC/decade output.

Specifications		
Measuring range in mbar	1×10 ⁻⁶ to 1333 mbar (7.6×10 ⁻⁷ to 1000 Torr)	
Measuring principle 1×10 ⁻⁶ to 1×10 ⁻² mbar	MEMS Pirani	
Measuring principle 1×10 ⁻² to 5×10 ⁻¹ mbar	Blended MEMS Pirani / capacitance	
Measuring principle 5×10 ⁻¹ to 4 mbar	Capacitance diaphragm gauge (CDG)	
Measuring principle 4 to 6 mbar	Blended MEMS Pirani / piezo reading	
Measuring principle 6 to 1333 mbar	MEMS piezo resistive diaphragm	
Accuracy ⁽¹⁰⁾ 1×10 ⁻⁶ to 9.99×10 ⁻³ mbar	25 % of reading	
Accuracy ⁽¹⁰⁾ 1×10 ⁻¹ to 9.99×10 ⁻¹ mbar	5 % of reading	
Accuracy ⁽¹⁰⁾ 1×10 ⁻² to 4.99 mbar	0.5% of reading	
Accuracy ⁽¹⁰⁾ 5.00 to 99.9 mbar	1% of reading	
Accuracy ⁽¹⁰⁾ 100 to 800 mbar	0.5% of reading	
Accuracy ⁽¹⁰⁾ 800 to 1099 mbar	0.25% of reading	
Accuracy ⁽¹⁰⁾ 1100 to 1333 mbar	0.5% of reading	
Hysteresis 1×10 ⁻² to 4.99 mbar	0.05% of reading	
Hysteresis 5 to 1333 mbar	0.1 % of reading	
Analog output resolution	16 bit (150 µV)	
Analog output update rate	124 Hz	
Response time (ISO 19685:2017)	<20 ms	
Temperature compensation	+10 to +50 °C	
Solid state relay set point range	1×10 ⁻² to 1333 mbar (7.5×10 ⁻³ to 1000 Torr)	
Solid state relay contact rating	50 V, 100 mA _{max} / mA _{cc}	
Solid state relay approvals	UL Recognized: File E76270 CSA Certified: Certificate 1175739 EN/IEC 60950-1 Certified	

Environment conditions	
Operating ambient temperature	-20 to +50 °C
Media temperature	-20 to +50 °C
Storage ambient temperature	-40 to +80 °C
Bake-out temperature (non-operating)	+80 °C
Maximum media pressure	4 bar absolute ⁽¹¹⁾
Mounting position	Arbitrary
Protection rating, EN 60529/A2:2013	IP40
Humidity, IEC 68-2-38	98%, non-condensing

Power supply	
Supply voltage	12-30 VDC
Power consumption	240 mW (max)
Reverse polarity protection	Yes
Overvoltage protection	Yes
Internal fuse	100 mA (thermal recoverable)

- (10) Accuracy specifications are typical values at stable temperature after zero adjustment.
- (11) Overpressure limits only applicable with using fittings rated to the specified

Materials	
Enclosure	AISI 316 Stainless steel / Aluminum 6061
Vacuum flange (media wetted)	AISI 316 Stainless steel
Vacuum exposed materials (media wetted)	AISI 316 Stainless steel, Kovar, glass, silicon, nickel, aluminum, Al ₂ O ₃ , SiO ₂ , Si ₃ N ₄ , gold, Viton®, low out-gassing epoxy resin, solder, Ro4350
Standard version	
Vacuum exposed materials (media wetted)	AISI 316 Stainless steel, Aluminum Oxide ceramic (Al ₂ O ₃), Viton®
Ceramic protected version	
Vacuum exposed materials (media wetted)	AISI 316 Stainless steel, Parylene, Viton®
Parylene protected version	

Approvals	
Process leak tightness	<1·10 ⁻⁷ mbar/l/s
CE	Directive 2014/30/EU
RoHS compliance	Directive EU 2015/863

Specifications are subject to change without further notice
Viton® is a trademark of THE CHEMOURS COMPANY FC, LLC

Dimensions

VPM-15 transducer with KF16 flange

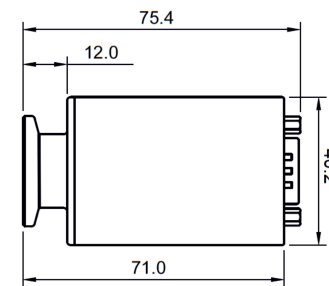

All dimensions are in mm unless otherwise stated – General tolerance ISO 2768-1 M

For dimensions of other flange types refer to Operating & Installation manual.

Measurement

The VPM-15 TriCAP™ is intended for measurement in the range from 1.0E-6 to 1333 mbar (7.5E-7 to 1000 Torr). When used in the range below 1.0E-5 mbar it is required to ensure adequate outgassing of water vapor from the internal surfaces of the transducer. After installing the transducer, it is recommended to perform a zero adjustment either by pressing the zero switch or sending the digital zero command when a base pressure below 5.0E-7 mbar is achieved. Before performing any adjustment or calibration refer to the procedure described in the Operating & Installation manual.

Status LED

The LED indicator signals the transducer status and can indicate the following basic indications:

Startup sequence

0.5 s purple followed by 4 s green pulse

Normal standard operation

Solid green

Sensor fail stage

5 Hz flash cycle



RGB pressure indicator

In dynamic mode the multi-color LED smoothly changes color throughout the pressure range. If the vacuum system is pressurized the LED provides a yellow flash warning.

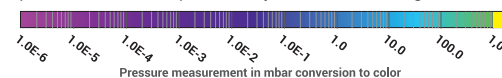

Maintenance

Maintenance is not required during the lifecycle of this product. Depending on the application, the calibration may shift during the life-time and re-calibration can be performed by the user. Refer to VPM-15 the Operating & Installation manual. The VPM-15 can be user configured, calibrated and tested using the S4-Connect™ programmer or USB programmer.

Return

Proper return forms and a return materials authorization (RMA) must be filled out before returning a product to Sens4. The RMA procedure can be found on: www.sens4.com/support/

Disposal in the European Union

At the end of life of this product, it must be disposed according to the European Directive 2012/19/EU (WEEE). This product should not be mixed with general household waste.



WARNING! If the product has been exposed to human or environmental hazards materials during its use, ensure proper decontamination before disposal.

For proper treatment, recovery and recycling, please take this product to designated collection points. Please contact your local authority for further details of your nearest designated collection point. For questions regarding disposal please contact your dealer or Sens4 for further information.

Declaration of Conformity

This declaration of conformity has been made in accordance with EN ISO/IEC 17050-1:2010

Manufacturer: Sens4 A/S
Address: Nordre Strandvej 119G
3150 Hellebaek
Denmark

We hereby declare under our sole responsibility that the following products:

Product description: Vacuum Pressure Transducer
Product part number: VPM-15-xxxxxxx

Complies with the requirements of following relevant European Union harmonization directive:
Electromagnetic Compatibility (EMC) Directive 2014/30/EU
RoHS Directive EU 2015/863

Conformity is assessed in accordance to the following standards:

Reference: Date	Title
EN 61326-1:2021	Product family standard, Measurement, control and laboratory equipment
EN 61326-2-3:2021	Test configuration, operational conditions and performance criteria for transducers with integrated or remote signal conditioning
EN 61000-3-3:2008	Limitation of voltage changes, voltage fluctuations and flicker in public low-voltage supply systems
EN 63000:2018	Technical documentation for the assessment of electrical and electronic products with respect to the restriction of hazardous substances

Signed on behalf of: Sens4 A/S
Place of issue: Hellebaek, Denmark
Date of issue: August 2nd 2021
Signature:

Name, Title: Ole Wenzel, Chief Executive Officer