



VPM-15 TriCAP™

Programmable precision vacuum pressure transducer

MEMS Pirani, Capacitance diaphragm and Piezo diaphragm

Voltage output

RS-232/RS-485 digital interface

Relay setpoints



OPM-VPM-15-01, Revision: 1.0, May 2026



Operating manual

Our passion | Your value™



Table of contents

General Information	3
Symbols used	3
Intended use	3
Safety information.....	3
Disposal in the European Union	3
Warranty	4
Returns.....	4
Liability.....	4
Trade restrictions and export control (ECCN: 2B230 Dual-use product).....	4
VPM-15 Vacuum Transducer	5
Labeling	5
About the VPM-15 Vacuum Transducer	6
Part Numbers	7
Configuration Accessories	8
Wall plug-powered USB converter and programmer	8
USB-powered converter and programmer	8
S4-Connect programmer	8
Software for configuration and on-screen measurement	8
Calibration	8
Mechanical Installation	9
Application and Process Compliance.....	9
Electrical Installation	10
Electrical connection (D-sub).....	10
Electrical Connection (Hirschmann GO-6 connector)	12
Electrical Connection (RJ45/8P8C connector).....	13
Status LED	14
Signal-to-pressure Conversion (0-10 VDC voltage output)	15
Other vendors analog output emulation	15
Digital vacuum pressure and temperature measurement	15
S4-Connect™ Communication.....	16
Getting started:.....	16
S4-Connect USB programmer LED signals.....	17
USB-to-Serial Converter.....	17
USB-to-Serial Converter.....	17
Command Set.....	18
Device Address (ADR)	19
Analog Output Configuration (AOUT)	20
Programmable linear analog output (AO).....	21
Set Baud Rate (BAUD)	21
Button Enabled (BTN).....	22
Sensor failure handling (FAIL).....	22
LED Behavior (LED)	22
Pressure measurement (P)	23
Quick data acquisitions (Q).....	23
Pirani and capacitance ratio measurement (RAT)	23
Temperature measurement (T).....	24
Unit (U).....	24
Statistics (STAT)	24
Sensor blending (BL).....	25
Setpoint Switch Function (Optional)	26
Configuration of Setpoints.....	27
Pre-configuration of setpoint values	28
Product Information and Identification.....	28
Serial number	28
Part number:.....	28
Manufacturer identity:.....	28
Firmware version:.....	28
Maintenance	29
Adjustment of the zero point	29
Adjustment of Full-scale	30
Resetting to Factory Default	31
900 Series Vacuum Transducer Compatibility	33
Return.....	33
RMA – Return Material Authorization.....	35
Specifications	36

Accessories	38
Declaration of Conformity	39
Contact and support.....	40

General Information

Thank you for purchasing this Sens4 product. This operating manual contains important safety information, and we encourage you to read this manual and the quick start guide prior to installation and use of this product.

Symbols used

The following symbols are used in this manual:



WARNING! Critical information to prevent dangerous situations that can result in serious injury or death.



CAUTION! Important information to prevent dangerous situations that can damage the device or auxiliary equipment.



ACTION! Requires action or attention.



INFORMATION: Important recommendations and information for efficient use and best practice.

Intended use

The VPM-15 vacuum transducer is intended for non-corrosive vacuum gas pressure measurement and control within the limits listed in the specifications on page 36. The device is designed for KF fittings or screw-in fittings mounting.

The device complies with EMC (Electro Magnetic Compatibility) class B immunity requirements for industrial environments.

Safety information

This product should be installed and operated by technically skilled or trained personnel only.



WARNING! This product is not intended for installation and use in the presence of flammable gases or other explosive environments.



WARNING! Ensure that the gases or liquids exposed to the wetted materials are compatible with the wetted materials described in the specifications table and the used sealing materials.



WARNING! The pressure rating of the sensor elements, connecting process fittings and sealing must comply with the maximum possible pressure in the application.

The CE marking on the device does not apply to the pressure equipment directive (PED) (2014/68/EU).



WARNING! Ensure that the process connection is tightened according to the recommended torque specification. Ensure that there are no leaks from the process connection before pressurizing the installation.



WARNING! Do not remove the transducer from the installation when the installation is evacuated, pressurized or contains hazardous fluids.

Disposal in the European Union

At the end-of-life of this product, it must be disposed according to the European Directive 2012/19/EU (WEEE). This product should not be mixed with general household waste.



WARNING! Ensure proper decontamination of the product before disposal if it has been exposed to humanly or environmentally hazardous materials during its use.



For proper treatment, recovery and recycling, please take this product to designated collection points. Please contact your local authority for further details of your nearest designated collection point.

Warranty

Sens4 warrants this product under normal use and service to be free from defects in materials and workmanship for a period of twenty-four (24) months from the date of the delivery.

Warranty does not cover mechanical damage, corrosive damage, physical contamination, deposition contamination, damage caused by shipping, normal wear and tear, incorrect use, misuse, incorrect installation or operation beyond the published design limits and specifications.

In case of warranty claim the customer should notify Sens4 immediately and no later than 3 weeks after the defect has been discovered. The warranty claim must specify the failure mode and other relevant information about the product defect and the application use. Sens4 can request return of a failed product for examination and root cause analysis that arises from a warranty claim. Sens4 will at its discretion credit, repair or replace the failed products that are accepted to be covered by warranty.

Warranty is void, regardless of the root cause of defect, if a product has been exposed to or contaminated with radioactive, chemical, biological or other harmful or dangerous substances.

The warranty does not apply to products that have been hardware modified, altered or dismantled by the customer or third party.

Software provided by Sens4 is supplied "as is" without warranty of any kind or guaranteed compatibility with customer IT systems and environment.

Returns

All returns to Sens4 must be authorized by Sens4 by issuing an RMA (Returned Material Authorization) prior to shipping. Contact Sens4 support to obtain an RMA number and fill out the form on page 35.

Sens4 will not accept return of products that have been exposed to or contaminated with radioactive, chemical, biological or any other harmful or dangerous substances.

Return of unpacked and unused products for credit requires written acceptance from Sens4 and will be subject to a handling fee.

Liability

The customer is solely responsible for determining the suitability and compatibility of the product for the customers application, environment and intended use. Sens4 is not liable for any claims arising from improper use, incorrect installation or use with gases or liquid not compatible with the media wetted materials described in the specifications table. To the extent permitted by law, Sens4 is not liable for incidental and consequential damages, including but not limited to loss of profits or revenue, overheads, loss of data, reinstallation costs, damage to other equipment or any incidental or consequential damages of any nature.

Sens4 has taken reasonable care to ensure that the content of its published information and specifications is accurate and up-to date. However, Sens4 does not guarantee or warrant that the content of the published information is error-free. Sens4 reserves the right to change its product specifications without prior notice.

Trade restrictions and export control (ECCN: 2B230 Dual-use product)

The TriCAP™ transducer is categorized as Dual-use product according ECCN: 2B230 and is subject to European Union and/or Danish trade and transfer laws and restrictions. In the event that the product is exported, transferred or in any way distributed to another country or territory than delivered to by Sens4, the recipient and/or customer is responsible for compliance to export restrictions, regulations or applicable law of Denmark, local law and/or the law of the European Union.

Diversion or transfer contrary to law of Denmark and/or law of the European Union is prohibited.

For export compliance questions consult your local authorities and/or Sens4 on email: info@sens4.com

VPM-15 Vacuum Transducer

The VPM-15 is available with different electrical connections and vacuum fittings. The illustration below is an example of the VPM-15 with D-sub connector and DN16KF vacuum fitting.



Labeling

If the serial label should become unreadable, the serial- and part numbers are also stored in the internal non-volatile memory and can be read using the S4-Connect™ USB programmer and communicator. See page 27.

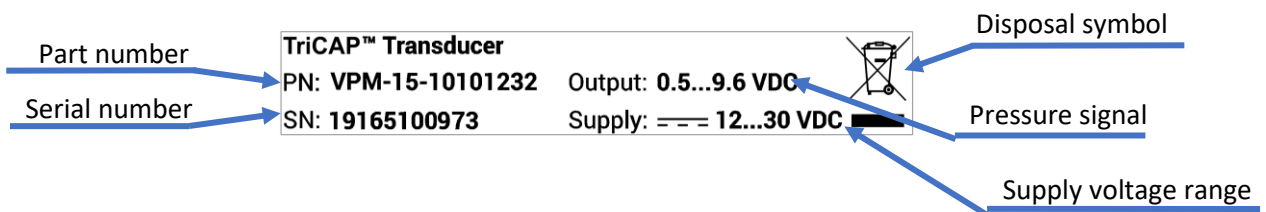

About the VPM-15 Vacuum Transducer

The VPM-15 TriCAP™ transducer is based on cutting-edge sensor technology and offers best-in-class performance and has established new standards by extending the useable measuring range for thermal conductivity vacuum gauges by 1-3 decades. The TriCAP™ combines a MEMS (Microelectromechanical Systems) heat-loss Pirani sensor, a Piezo diaphragm sensor and a capacitance diaphragm sensor.

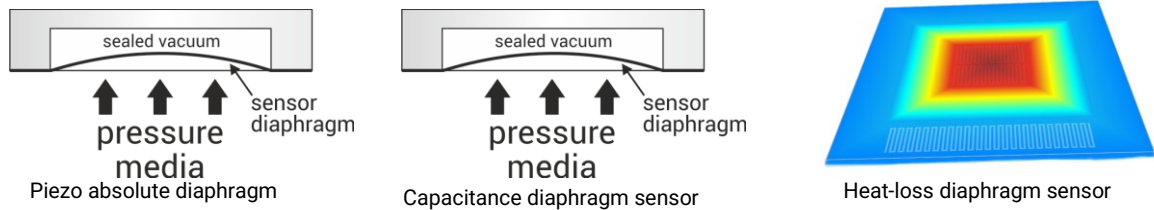

The piezo MEMS sensor consists of a diaphragm where one side of the diaphragm is exposed to the vacuum gas and the other side is exposed to a sealed reference vacuum. The applied pressure deflects the diaphragm and the deflection is converted to an electric signal.

The MEMS Pirani sensor is based on a resistive element deposited on an ultra-thin diaphragm suspended in the vacuum gas to measure. The diaphragm is permanently mechanically fixed and does not bend or move with changes in vacuum gas pressure. The resistive element is made of nickel that offers a high temperature coefficient. The vacuum gas pressure is determined by measurement of the pressure dependent heat-loss from a heated resistive element. The measurement of heat-loss is gas concentration and gas type dependent.

The ceramic capacitance gauge is based on an elastic sensor diaphragm where the mechanical deflection is a function of the applied pressure. The diaphragm constitutes an electrode and together with an integrated auxiliary electrode it forms a pressure dependent capacitor that in an electrical measurement circuit converts the applied pressure to an electrical signal.

The precision capacitance diaphragm gauge (CDG) sensor eliminates the Pirani gas dependency and provides accurate measurements also when the gas properties change.

Measurement performance

The VPM-15 TriCAP™ has established new performance standards and extended range for heat-loss Pirani gauges. It combines a MEMS diaphragm piezo sensor, a heat-loss MEMS Pirani sensor and a ceramic capacitance diaphragm sensor.

The diaphragm sensors eliminates the well-known gas dependency in the rough vacuum range of thermal conductivity gauges. The Piezo offers precision performance comparable to more expensive capacitance manometers. This feature ensures more accurate control of vacuum system venting processes and can prevent over-pressurization of the vacuum system.

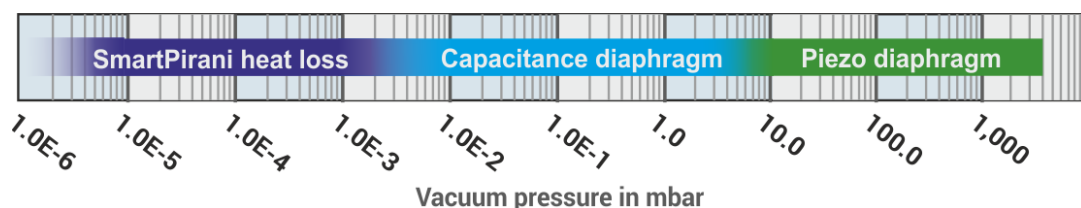

The MEMS-Pirani provides measurement resolution down to 1.00E-6 mbar (7.5E-7 Torr). When For measurement in the range below 1.0E-5 mbar it's recommended to perform zero adjust

Part Numbers

The VPM-15 is available with different electrical connections and process fittings. The illustration below is an example of the VPM-15 with DN16KF, RS-232/S4-Connect™, 0.5-9.5 VDC analog output, mbar unit, 3 relays and 15-pin HD D-sub

VPM-15-	1	0	1	0	1	2	3	2	
Vacuum flange									Connection
DN16KF	1	0							1 9 Pin D-sub male
DN25KF	2	0							2 15 pin HD D-sub male
NPT 1/8"	3	0							3 15 pin HD D-Sub male / dual analog out
VCR4	4	0							4 6 pin Hirschmann, ID res 3K
VCR8	5	0							5 6 pin Hirschmann, ID res 5.1K
DN16KF Extended	8	0							6 6 pin Hirschmann, ID res 9.1K/11.1K
DN16CF Rotatable	6	0							7 8 pin RJ45 / FCC68, ID Res 27K
DN16KF with light baffle	1	1							8 8 pin RJ45 / FCC68, ID Res 36K
DN16KF with heavy duty baffle	1	2							9 8 pin RJ45 / FCC68, ID Res 43K
DN25KF with light baffle	2	1							A 8 pin RJ45 / FCC68, ID Res 71K5
DN25KF with heavy duty baffle	2	2							B 8 pin RJ45 / FCC68, ID Res 85K
DN16KF, Ceramic protected sensors	1	3							
DN25KF, Ceramic protected sensors	2	3							Setpoints
NPT 1/8", Ceramic protected sensors	3	3							0 None
VCR4 female, Ceramic protected sensors	4	3							1 1x Solid State Relay
VCR8 female, Ceramic protected sensors	5	3							2 2x Solid State Relays
DN16CF rotatable, Ceramic	6	3							3 3x Solid State Relays
DN16KF Extended, Ceramic	8	3							
DN16KF with light baffle, Ceramic	1	4							Unit
DN16KF with heavy duty baffle, Ceramic	1	5							1 torr
DN25KF with light baffle, Ceramic	2	4							2 mbar
DN25KF with heavy duty baffle, Ceramic	2	5							3 Pascal
DN16KF, Parylene protected sensors	1	6							
DN25KF, Parylene protected sensors	2	6							
NPT 1/8", Parylene protected sensors	3	6							
VCR4 female, Parylene protected sensors	4	6							
VCR8 female, Parylene protected sensors	5	6							
DN16CF rotatable Parylene protected sensor	6	6							
DN16KF Extended, Parylene protected sensor	8	6							
DN16KF with light baffle, Parylene	1	7							
DN16KF with heavy duty baffle, Parylene	1	8							
DN25KF with light baffle, Parylene	2	7							
DN25KF with heavy duty baffle, Parylene	2	8							
Digital interface									
RS-232 / S4-Connect™									1
RS-485 / S4-Connect™									2
S4-Connect™ (RJ45/FCC68 and Hirschmann)									3
Analog Output									
0.5 - 9.5 (1 V/dec)						0			1
1.0-9 VDC 1 VDC/Dec (MKS 901P/925/910)						0			2
0.375 to 5.659 VDC (MKS GP275)						0			3
0.5V DC (MKS 523)						0			4
1.9-10 VDC (Inficon PSG55x, Leybold TTR91)						0			5
1.5-8.5 VDC (Pfeiffer TPR260/27x/28x)						0			6
1.9-9.1VDC (Edwards APG100XLC)						0			7
1.9-9.1VDC (Edwards APG100XM)						0			8
2-10VDC (Edwards APG-L)						0			9
0-10 VDC 0.1 Torr FS Capacitance manometer					1				0
0-10 VDC 1 Torr FS Capacitance manometer					1				1
0-10 VDC 10 Torr FS Capacitance manometer					1				2
0-10 VDC 100 Torr Capacitance manometer					1				3
0-10 VDC 1000 Torr Capacitance manometer					1				4
2.0-8.6 VDC (MPG400/Pfeiffer PKR251, PKR261)					1				5
0.61-10.2 VDC (Leybold TTR101N)					3				5
1.8-8.6 VDC (Pfeiffer PKR251)					3				6
0-10VDC 0.1 mbar FS Capacitance manometer					5				0
0-10VDC 1 mbar FS Capacitance manometer					5				1
0-10VDC 2 mbar FS Capacitance manometer					5				2
0-10VDC 5 mbar FS Capacitance manometer					5				3
0-10VDC 10 mbar FS Capacitance manometer					5				4
0-10VDC 20 mbar FS Capacitance manometer					5				5
0-10VDC 50 mbar FS Capacitance manometer					5				6
0-10VDC 100 mbar FS Capacitance manometer					5				7
0-10VDC 200 mbar FS Capacitance manometer					5				8
0-10VDC 500 mbar FS Capacitance manometer					6				9
0-10VDC 1100 mbar Capacitance manometer					6				0
0-10VDC 1000 mbar Capacitance manometer					6				1

Other analog outputs are available on request

Configuration Accessories

When configuring the various digital and analog parameters of the VPM-15, three different categories of connectors can be used – as described in the following sections.

Neither of these connectors are included with the transducer and must be purchased separately.

Wall plug-powered USB converter and programmer

The wall plug-powered variant includes either a USB-to-RS-232 or USB-to-RS-485 converter along with a 90-230 VAC wall plug power supply that enables powering of the transducer independently of a PC.



The wall plug power supply is compatible with VPM-15 transducers and MKS 901P, 902B, 910, 925, 971B, 972B and 974B.

Part number	Description
PRG-RS2-DS15-WP	RS-232 USB programmer, 1.5 m cable, D-sub 15 pin, wall plug-powered
PRG-RS4-DS15-WP	RS-485 USB programmer, 1.5 m cable, D-sub 15 pin, wall plug-powered
PRG-RS2-DS9-WP	RS-232 USB programmer, 1.5 m cable, D-sub 9 pin, wall plug-powered
PRG-RS4-DS9-WP	RS-485 USB programmer, 1.5 m cable, D-sub 9 pin, wall plug-powered

USB-powered converter and programmer

The USB-powered converter and programmer provides direct USB communication and power from the PC.



The USB-powered programmer is compatible with VPM-15 transducers and MKS 901P, 902B, 910 and 925 transducers.

Part number	Description
PRG-RS2-DS15-UP	RS-232 USB programmer, 1.5 m cable, D-sub 15 pin, USB powered
PRG-RS4-DS15-UP	RS-485 USB programmer, 1.5 m cable, D-sub 15 pin, USB powered
PRG-RS2-DS9-UP	RS-232 USB programmer, 1.5 m cable, D-sub 9 pin, USB powered
PRG-RS4-DS9-UP	RS-485 USB programmer, 1.5 m cable, D-sub 9 pin, USB powered

S4-Connect programmer

The S4-Connect communicates digitally via the power supply line, enabling configuration of products that would otherwise not have a standard digital interface like RS-232 or RS-485.



S4-Connect is available in four configurations:

Part number	Description
PRG-S4-RJ45	S4-Connect™ USB programmer, 1.5 m cable, RJ45, 8-pin
PRG-S4-HIR6	S4-Connect™ USB programmer, 1.5 m cable, Hirschmann GO-6, 6-pin

Software for configuration and on-screen measurement

The S4-Connect™ and RS-232/485 software is freeware and can be downloaded from the Sens4 website: <https://www.sens4.com/support/>

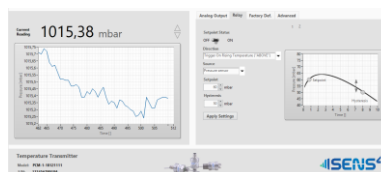

Calibration

The VPM-15 is delivered factory-calibrated with a calibration test report. An optional accredited DAKKS calibration traceable to national standards can also be supplied with the VPM-15 transducer.

Mechanical Installation

The VPM-15 transducer is available with KF clamp fittings, VCR screw-in fittings or CF fittings.



CAUTION! For screw-in fittings do not exceed tightening torque values.



CAUTION! Use gloves when handling vacuum fittings. Ensure that the O-ring and vacuum sealing surfaces are clean and free of scratches or other damages.

The VPM-15 transducer can be mounted horizontally or vertically without impact on accuracy or performance.

Application and Process Compliance

The standard VPM-15 TriCAP™ is intended for use with inert gases. For vacuum environments where exposure to corrosive or aggressive gases may occur, optional conformal protective ceramic or Parylene coatings are available.

Ceramic is highly corrosion resistant and is a well-proven material for vacuum sensor diaphragms used in capacitance diaphragm gauges.

Parylene is a unique polymer with excellent corrosion-resistant and hydrophobic properties. The Parylene barrier is designed for demanding applications, including medical processes such as lyophilization and sterilization.

In some vacuum processes, particulates can damage vacuum gauges. For these applications, TriCAP™ transducers are available with a protective baffle that acts as a barrier to macroscopic particles.

Combined with the available protective coating options, TriCAP™ transducers are well suited for operation in harsh and demanding vacuum environments.



Electrical Installation

The VPM-15 requires an external power supply supplying in the range 12-30 VDC. The external power supply shall be with safe isolation according to PELV (Protective Extra Low Voltage) requirements of EN60204-1. The transducer is protected against momentary overvoltage on the supply line. The internal 100 mA thermal fuse will limit current draw in case of overvoltage to limit overheating. Additionally, the transducer is protected against reverse polarity caused by incorrect wiring to the power supply.

The transducer electronics have a high level of immunity against external electromagnetic interference.

Electrical connection (D-sub)

The voltage output version provides a voltage signal proportional to the measured pressure.

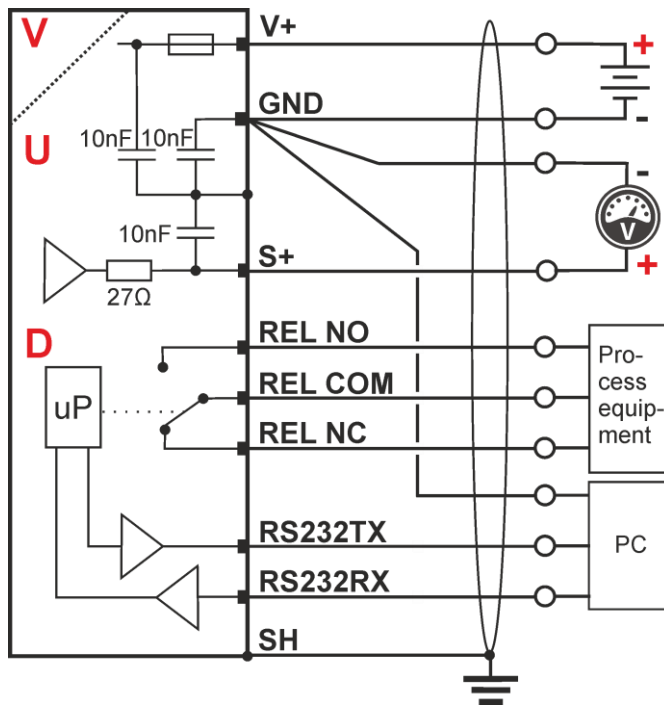

The high resolution 16-bit voltage signal can be interfaced to a PLC, A/D converter, voltmeter or other readout devices.



INFORMATION: It is recommended to use a differential input to measure the output signal that uses a separate signal return wire connected to the transducer connector. If power supply return and signal return share the same wire connection the voltage drop as function of supply current will cause a measurement deviation. In that case, the measurement deviation will increase with the cable length.

Connector pinout and cable wiring (0-10 VDC voltage output)

15-pin HD D-sub connector

Pin	Symbol	Description
1	RS232TX	RS-232 Transmit / RS-485 (-)
2	RS232RX	RS-232 Receive / RS-485 (+)
3	V+	Supply voltage 12-30 VDC
4	GND	Supply voltage - (return)
5	S+	Analog voltage signal +
6	GND	Analog voltage signal - (return)
7	REL NO	Relay 1 NO (normally open contact) ⁽¹⁾
8	REL COM	Relay 1 Common ⁽¹⁾
9	REL NC	Relay 1 NC (normally closed contact) ⁽¹⁾
10	REL NC	Relay 2 NC (normally closed contact) ⁽¹⁾
11	REL COM	Relay 2 Common ⁽¹⁾
12	REL NO	Relay 2 NO (normally open contact) ⁽¹⁾
13	REL NC	Relay 3 NC (normally open contact) ⁽¹⁾
14	REL COM	Relay 3 Common ⁽¹⁾
15	REL NO	Relay 3 NO (normally open contact) ⁽¹⁾

(1) Optional relay

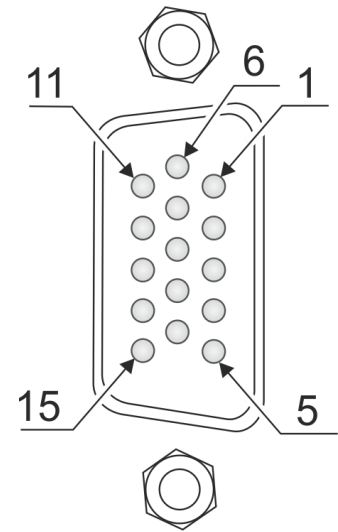

9-pin D-sub connector

Pin	Symbol	Description
1	REL NO	Relay 1 NO (normally open contact) ⁽¹⁾
2	REL NC	Relay 1 NC (normally closed contact) ⁽¹⁾
3	V+	Supply voltage 12-30 VDC
4	GND	Supply voltage - (return)
5	S+	Analog voltage signal +
6	REL COM	Relay 1 Common ⁽¹⁾
7	RS-232TX	RS-232 Transmit / RS-485 (-)
8	GND	Analog voltage signal - (return)
9	RS-232RX	RS-232 Receive / RS-485 (+)

(1) Optional relay

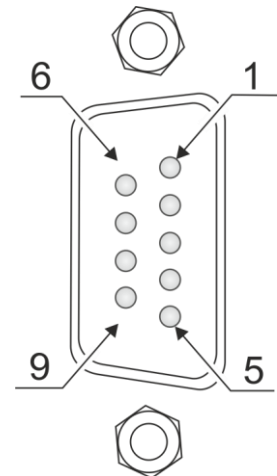

Electrical Connection (Hirschmann GO-6 connector)

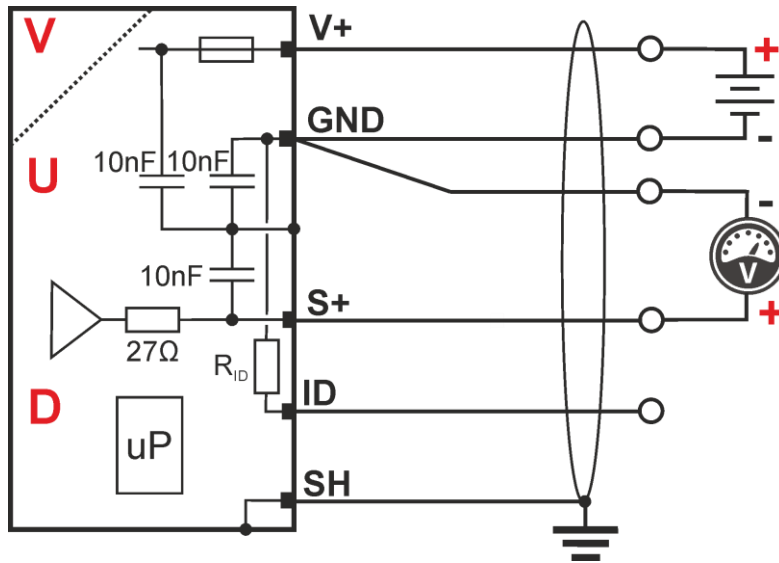

6-pin Hirschmann GO-6 connector

Pin	Symbol	Description
1	ID	Identification resistor (3K)
2	S+	Analog voltage signal +
3	GND	Analog voltage signal - (return)
4	V+	Supply voltage 12-30 VDC
5	GND	Supply voltage - (return)
6	CH	Chassis

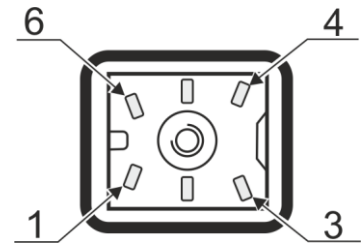

INFORMATION: It is recommended to use a differential input to measure the output signal that uses a separate signal return wire connected to the transducer connector. If power supply return and signal return share the same wire connection the voltage drop as function of supply current will cause a measurement deviation. In that case, the measurement deviation will increase with the cable length.

Electrical Connection (RJ45/8P8C connector)

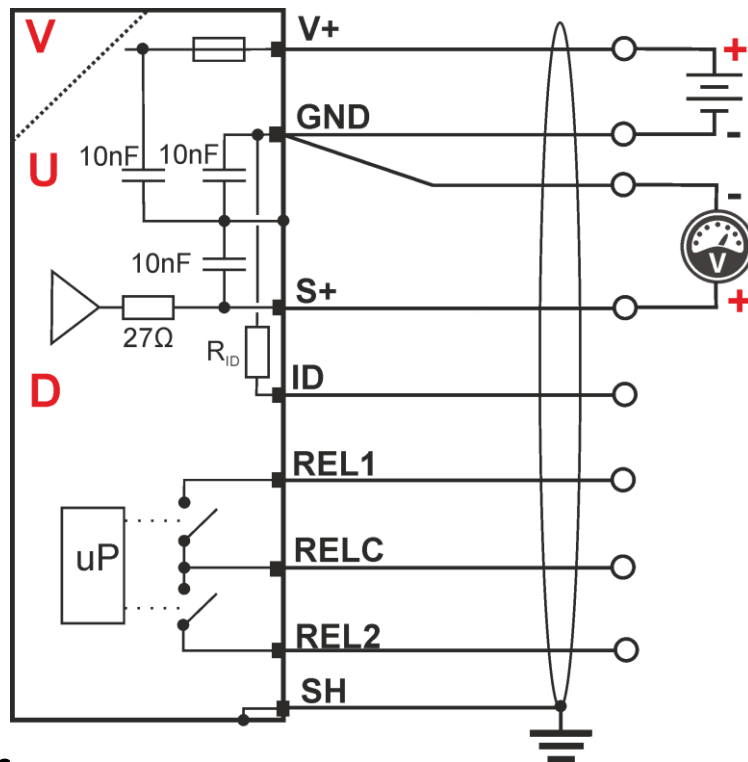

RJ45/8P8C connector

Pin	Symbol	Description
1	V+	Supply voltage 12-30 VDC
2	GND	Supply voltage - (return)
3	S+	Analog pressure voltage signal +
4	ID	Identification resistor ⁽⁷⁾
5	GND	Analog voltage signal - (return)
6	REL2	Relay 2 Setpoint (closing contact)
7	REL1	Relay 1 Setpoint (closing contact)
8	RELC	Relay 1 and 2 common

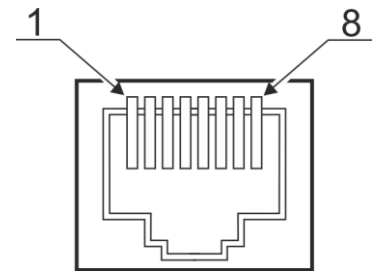

(7) Identification resistor for RJ45/8P8C connector

The identification resistor is used by external equipment to identify the type of transducer. External equipment can be a display or a controller from another vendor. The VPM-15 is available with different ID resistors. The ID resistor is identified by the last digit in the part number:

P/N	ID resistor value
7	27 KΩ
8	36 KΩ
9	43 KΩ



INFORMATION: It is recommended to use a differential input to measure the output signal that uses a separate signal return wire connected to the transducer connector. If power supply return and signal return share the same wire connection the voltage drop as function of supply current will cause a measurement deviation. In that case, the measurement deviation will increase with the cable length.

Status LED

The LED indicator signals the transducer status and can indicate following basic indications:

Startup sequence

- 0.5 sec purple followed by 4 sec. pulsing green

Normal standard operation

- Solid green

Overpressure indication (in Dynamic Mode only)

- Flashing Orange (5 Hz)

S4-Connect mode

- Pulsing green

Sensor fail stage

- Flashing red (5 Hz)



RGB LED for pressure indication (Dynamic mode)

The VPM-15 SmartPirani™ introduces a new approach for visually determining the measured pressure by a multi-color LED that smoothly changes color throughout the pressure range. This selectable visual function is a low-cost alternative to integrated displays and provides a rough visual indication of the measured pressure.

When the VPM-15 measures a pressure that exceeds its maximum measuring range of 1333 mbar (1000 Torr) the LED will blink orange.

The dynamic LED can be enabled via the digital interface. Refer to page 22 for LED configuration.

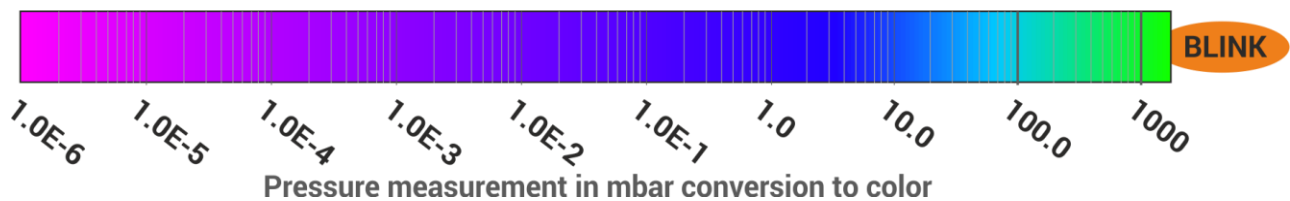

Signal-to-pressure Conversion (0-10 VDC voltage output)

The transducer can provide a voltage output from 0-10 VDC and is available with different types of pre-configured output scaling.

In the VPM-15's standard configuration with a voltage output of 1 VDC/decade, the output is scaled according to the configured pressure unit, e.g. when mbar is selected the transducer will provide 1 VDC per decade mbar. Likewise, when the unit is changed to torr, the transducer will provide 1 VDC per decade torr. Finally, when the unit is changed to Pascal, the transducer will provide 1 VDC per decade Pascal.

The voltage signal u can be converted to pressure using the following linear expression:

Voltage to pressure conversion (mbar and torr): $P(u) = 10^{(u-6.5)}$

Voltage to pressure conversion (Pascal): $P(u) = 10^{(u-4.5)}$

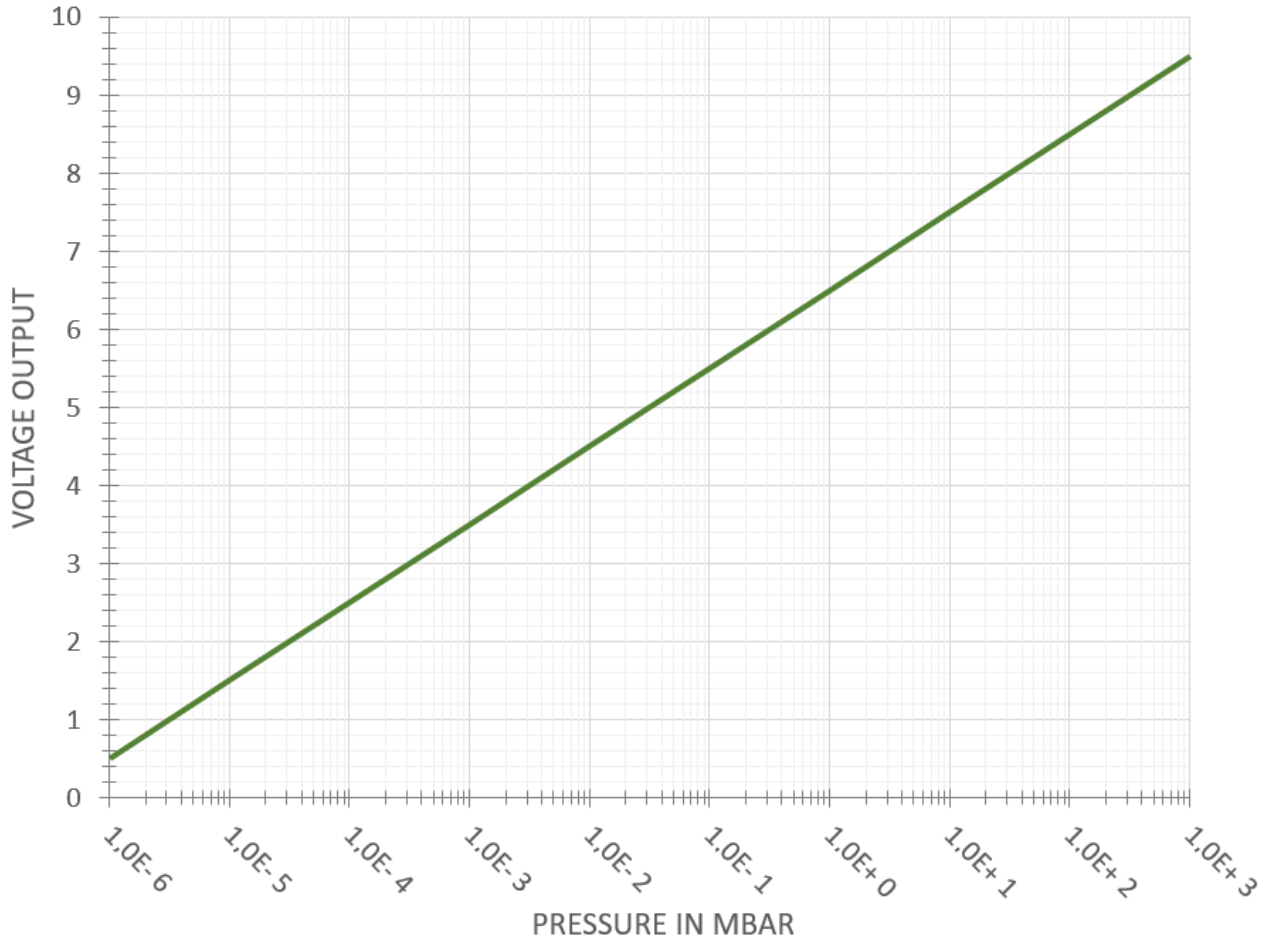

Other vendors analog output emulation

The VPM-15 analog output emulation offers voltage output pressure scaling compatible with other vendors gauges. This feature enables drop-in replacement of gauges from other vendors. Configuration and list of analog output options can be found on page 18-19.

Digital vacuum pressure and temperature measurement

The real-time digital vacuum gas pressure value and vacuum gas temperature can be acquired through the digital interface. Refer to digital command set on page 17.

S4-Connect™ Communication



The S4-Connect™ USB programmer and communicator provides access from PC software via a USB interface to the digital core of the transducer. It is compatible with both 4-20 mA current output and 0-10 VDC voltage output transducers from Sens4.



It is intended for configuration, calibration and setup of the unit, but it can also be used to acquire measurement data and perform diagnostics using a PC.

The S4-Connect™ interface enables easy and cost-optimized access to perform calibration, adjustments and individual configuration of the transducer product to fit the customer application and requirements.

During the power-up cycle the transducer will detect if there is a S4-Connect™ programmer connected and if so, the transducer will enter the S4-Connect™ service mode.



WARNING! The S4-Connect™ interface is not intended for digital communication between process equipment and the VPM-15 transducer unit. Disconnect the transducer from any external installation before enabling the S4-Connect™ service mode. During the S4-Connect™ service mode the analog voltage output or analog current output will be disabled, and the analog output will be used for digital communication between transducer and S4-Connect™ programmer.

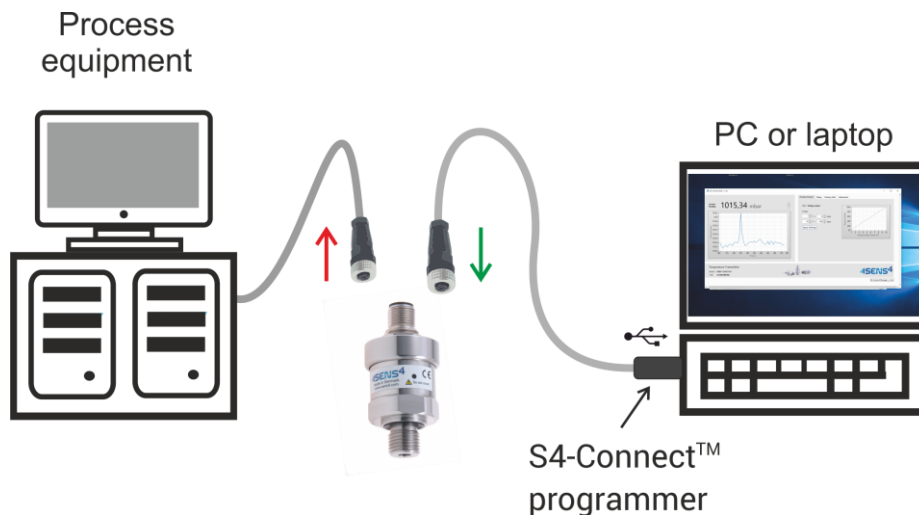

Getting started:

1. Remove the electronics connection to the transducer so that it is disconnected from any process equipment.
2. Download the S4-Connect™ software from www.sens4.com and install the software. Alternatively, a standard serial terminal software can be used.
3. Connect the programmer to the PC and the S4-Connect™ software. The S4-Connect™ programmer will then enter a state where it searches for the transducer. During this period the LED on the programmer will alternate between green and blue.
4. Connect the transducer to the S4-Connect™ cable. The S4-Connect™ programmer's LED will turn solid green if a current output transducer is connected and solid blue if a voltage output transducer is connected.
5. When the S4-Connect™ programmer's LED turns solid blue or green, it's ready for communication.

S4-Connect USB programmer LED signals

The S4-Connect™ USB programmer has an LED indicator that provides the following signals:

- ● Alternating blue/green: Searching for transducer.
- Solid blue: Voltage output transducer connected.
- Solid green: Current output transducer connected.
- White strobe: Locate mode for S4-Connect™ programmer (see page 19).

USB-to-Serial Converter

The USB-to-Serial Converter is the quickest and simplest way to provide connectivity between an RS-232 or RS-485 capable Sens4 transducer and a computer or other compatible device.

Featuring a built-in switch-mode power supply, the converter eliminates the need for an external power supply.



USB-to-Serial Converter

The USB-to-Serial Converter is the quickest and simplest way to provide connectivity between an RS-232 or RS-485 capable Sens4 transducer and a computer or other compatible device.

Featuring a built-in switch-mode power supply, the converter eliminates the need for an external power supply.



Command Set

The VPM-15 is available with S4-Connect and either an RS-232 or an RS-485 serial interface. Communication is based on an ASCII protocol that includes a start character, device address, command or query and an end character for termination:

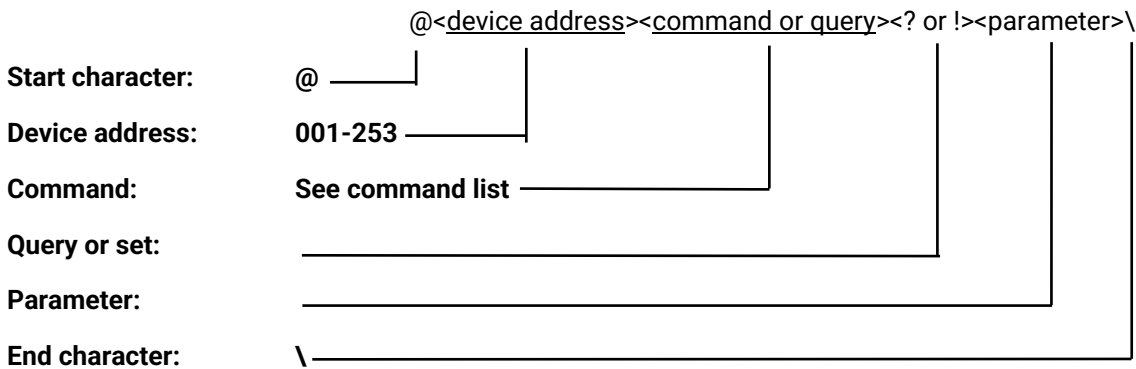

INFORMATION: Throughout this manual the signs <> are written for separation of command name and values and are for informational purposes only. These signs should not be entered in the actual command

Example of how to send a command to the transducer

Programming the Setpoint 1 value to 1.23E-4 (using the default unit setting of the transducer, i.e. mbar):

Send: @254SPV!1,1.24E-4\
Reply: @ACK1.23E-4\

The following table lists all commands supported by VPM-15. Each command is described in more detail below the table.

Command	Description	Query	Set	Valid input parameter
ADR	Device address	•	•	1-3 digits (range 001-253)
AOUT	Analog output configuration	•	•	<STD / 0-39>
BAUD	Set baud rate	•	•	<4800 / 9600 / 19200 / 38400 / 57600 / 115200> (default 9600)
FAIL	Sensor failure handling	•	•	<WORKING / ZERO >
FD	Factory default	•	•	<ADR / BAUD / GT / SP / U / (NONE)>
FS	Piezo full-scale adjustment	•	•	<PRESSURE VALUE / CLEAR>
FV	Firmware version	•	-	-
GT	Gas type	•	•	<NITROGEN / HELIUM / ARGON / AIR>
MF	Manufacturer	•	-	-
MD	Model name	•	-	-
P	Pressure measurement	•	-	<CMB / MP / PZ / CP / (none)>
PN	Part number	•	-	-
Q	Quick query	•	•	<Parameter 1>, <Par. 2> ... <Par. 5>
SN	Serial number	•	-	-
SP	Setpoint settings	•	-	-
SPD	Setpoint direction ⁽¹⁾	•	•	<SETPOINT #>, <ABOVE / BELOW>
SPE	Setpoint enable ⁽¹⁾	•	•	<SETPOINT #>, <OFF / ON>
SPH	Setpoint hysteresis ⁽¹⁾	•	•	<SETPOINT #>, <PRESSURE VALUE>
SPV	Setpoint value ⁽¹⁾	•	•	<SETPOINT #>, <PRESSURE VALUE>
SPR	Setpoint relay status ⁽¹⁾	•	-	<SETPOINT #>
SPS	Setpoint source ⁽¹⁾	•	•	<SETPOINT #>, <P / T>
STAT	Statistics	•	•	<P / T / (none) / CLEAR (Set only)>
T	Vacuum sensor temperature	•	-	-
U	Pressure unit	•	•	(<PARAMETER>), <MBAR / PASCAL / TORR> or <CELSIUS / FAHRENHEIT / KELVIN>
VAC	Pirani Zero adjustment	•	•	No input or <PRESSURE VALUE>

General note: all valid input parameters written in *italics* are to be entered as a number. These numbers will vary with the type and model number of the transducer. Refer to the specific commands for details.

(1) Setpoint solid-state relay is optional and is not relevant for all part numbers.

Device Address (ADR)

The VPM-15 has an addressable communication protocol, and so it will only accept commands or queries with the following addresses. All queries or commands sent to all other addresses are simply ignored.

<device address>	Pre-configured to 253, this value may be changed at any time to anything in the range 1-253 using the ADR command.
254	This is the "global" address. The VPM-15 will always respond to commands or queries at address 254, regardless of the device address setting.
255	This is the broadcast address, which may be used for performing the same operation on multiple VPM-15s at once. The VPM-15 will not issue any replies to broadcast commands. Note that broadcasting requires a multidrop communication interface such as RS-485.

Example: Change the device address from 253 (default) to 123 using the global address:

Send: **@254ADR!123**

Reply: **@253ACK123**

All replies after this one will begin with the new device address, 123.

Analog Output Configuration (AOUT)

VPM-15's default analog output is 0.5-9.5 V, 1V/decade, however, the analog output can be configured to emulate a collection of other equipment via the AOUT command:

	Vendor	Transducer model	Output
STD	Sens4	VPM-4, 5, 7, 15, 17	1 VDC/decade (0.5-9.5VDC)
LINEAR	Sens4	-	Programmable linear
0	MKS	901P, 910, 925	1 VDC/decade
1	Edwards	APG-L	1.99 - 10 VDC
2	Edwards	APG-100	2.00 - 9.00 VDC
3	Edwards	WRG	2.75 - 10.00 VDC
4	Inficon Leybold	PSG500 TTR91	1.547 - 10.00 VDC
5	Inficon Pfeiffer	MPG400 PKR251	2.07 - 8.603 VDC
6	Inficon MKS	BPG400 999 Quattro	1.843 - 10.00 VDC
7	MKS Granville Phillips	275	0.372 - 5.570 VDC
8	MKS HPS	Moducell 325	0.2509 - 3.2398 VDC
9	MKS HPS	Moducell 325 x3	0.753 - 9.719 VDC
10	MKS	Baratron® 0.1 Torr	0 - 10.00 VDC
11	MKS	Baratron® 1 Torr	0 - 10.00 VDC
12	MKS	Baratron® 10 Torr	0 - 10.00 VDC
13	MKS	Baratron® 100 Torr	0 - 10.00 VDC
14	MKS	Baratron® 1000 Torr	0 - 10.00 VDC
15	MKS	901P piezo differential output	1 VDC/decade
16	Edwards	AIM-S / - SL	2.5 - 10.00 VDC
17	Edwards	AIM-X / XL	3.286 - 9.799 VDC
18	Pfeiffer	IKR251	2.324 - 8.500 VDC
19	Pfeiffer	TPR 265 / 280	2.199 - 8.625 VDC
20	Hastings	HPM-2002-OBE special	5.00 - 9.995 VDC
21	Edwards	DV6M	2.00 - 10.00 VDC
22	Edwards	APG-M	2.00 - 10.00 VDC
23	MKS Granville Phillips	GP275 (0-9.0 VDC)	0 - 9.00 VDC
24	Thyracont	MT 241.1	0.41 - 9.99 VDC
25	MKS Granville Phillips	GP275 (0.375-5.659 VDC)	0.375 - 5.659 VDC
26	Edwards	APG100-LC	2.00 - 10.00 VDC
27	Edwards	APG100M	2.00 - 10.00 VDC
28	MKS	907	0.387 - 5.666 VDC
29	Alcatel	K6080	0.40 - 10.00 VDC
30	Inficon	PEG100	2.186 - 10.166 VDC
31	Varian	Esys	1.00 - 8.00 VDC
32	Alcatel	TA111	0.10 - 9.20 VDC
33	MKS	685	1.00 - 7.00 VDC
34	MKS	901P special 2VDC/decade	1.00 - 9.00 VDC
35	Pfeiffer	TTR 101	0.61 - 10.2 VDC
50	MKS/Inficon	0.1 mbar full scale (linear)	0 - 10.00 VDC
51	MKS/Inficon	1 mbar full scale (linear)	0 - 10.00 VDC
52	MKS/Inficon	2 mbar full scale (linear)	0 - 10.00 VDC
53	MKS/Inficon	5 mbar full scale (linear)	0 - 10.00 VDC
54	MKS/Inficon	10 mbar full scale (linear)	0 - 10.00 VDC
55	MKS/Inficon	20 mbar full scale (linear)	0 - 10.00 VDC
56	MKS/Inficon	50 mbar full scale (linear)	0 - 10.00 VDC
57	MKS/Inficon	100 mbar full scale (linear)	0 - 10.00 VDC
58	MKS/Inficon	200 mbar full scale (linear)	0 - 10.00 VDC
59	MKS/Inficon	500 mbar full scale (linear)	0 - 10.00 VDC
60	MKS/Inficon	1000 mbar full scale (linear)	0 - 10.00 VDC
61	MKS/Inficon	1100 mbar full scale (linear)	0 - 10.00 VDC

Example: Change the Analog output emulation to MKS Baratron 0.1 Torr:

Send: @254AOUT!10\
Reply: @253ACK10\
The VPM-15 is available with a hardware optional secondary analog output. The output can be configured to the same output curves as the primary analog output.

Example: Change the Analog output emulation to Pfeiffer TTR101 analog output:

Send: @254AOUT!2,35\
Reply: @253ACK2,35\
Example: Change the Analog output emulation to Pfeiffer TTR101 analog output:

Send: @254AOUT!2,35\
Reply: @253ACK2,35\
Example: Change the Analog output emulation to Pfeiffer TTR101 analog output:

Programmable linear analog output (AO)

When selecting Aout to "Linear" the analog output configuration can be user configured to any linear scaling within the VPM-15 measuring range and output limitation. This feature allows magnification of a specific pressure range.

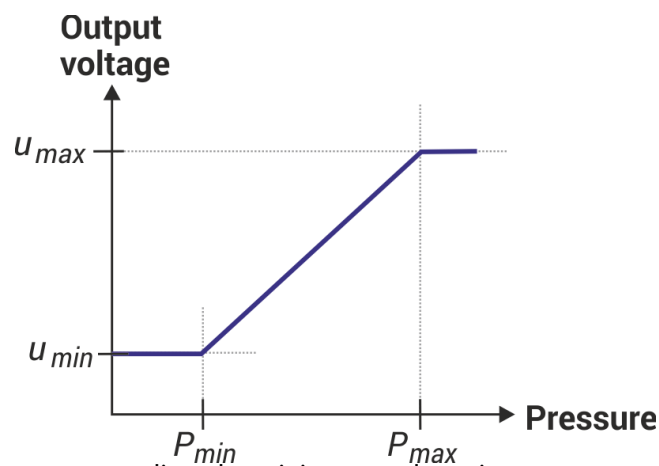

Configuration of output:

When programming the voltage output scaling, the minimum and maximum output voltage must be entered in millivolt and the minimum and maximum pressure in transducer configured pressure unit.

Command syntax:

AO!<Output1&2>, <LOW PRESSURE VALUE>,<HIGH PRESSURE VALUE>,<LOW VOLTAGE VALUE>,<HIGH VOLTAGE VALUE>

Example: Configure the analog 1 output linear expression between 1 VDC @ 10 mbar and 10 VDC @ 100 mbar.

Send: @254AO!1,10,1000,100,10000\
Reply: @253ACKAO
ANALOG OUT 1
#: PRESSURE, AOUT [mV]
L: +1.00E+01, 1000
H: +1.00E+02, 10000\
The graph shows Output voltage mV on the y-axis and Pressure mbar on the x-axis. The y-axis has two marked points: 1,000 and 10,000. The x-axis has two marked points: 10.00 and 100.00. A blue line starts at $(10.00, 1000)$, rises linearly to $(100.00, 10000)$, and then remains constant at 10,000 mV for pressures greater than 100.00 mbar. The points are labeled "Lower point (L)" and "Upper point (H)".

Reply: @253ACKAO
ANALOG OUT 1
#: PRESSURE, AOUT [mV]
L: +1.00E+01, 1000
H: +1.00E+02, 10000

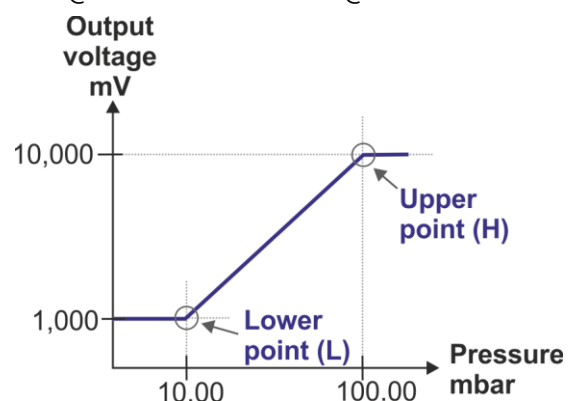

Set Baud Rate (BAUD)

The VPM-15 supports the following baud rates: 4800, 9600, 19,000, 38,400, 57,600, 115,200. Note that whenever the baud rate is changed, the VPM-15 will send an acknowledgement to the BAUD command using the old baud rate setting before switching to the new one.

Example: Change the baud rate to 115.200:

Send: @254BAUD!115200\
Reply: @253ACK115200

Example: Change the baud rate to 115.200:

Button Enabled (BTN)

Enable or disable the feature to perform Pirani zero-adjustments and Differential Piezo zero-adjustments via the VPM-15's push-button.

Example: Disable the push-button.

Send: `@254BTN!OFF\`

Reply: `@253ACKOFF\`

Sensor failure handling (FAIL)

The VPM-15 can be configured to handle sensor failure in two different ways:

- Switch the Combined Pressure output (P? or P?CMB) and Analog Output to only use the working sensor, i.e. if the Piezo sensor is malfunctioning, the combined output is only based on the Vacuum Pirani and vice versa.
- Set both the Combined Pressure output and the Analog Output to zero in case of sensor errors to signal an error condition.

Parameter	Description
WORKING	Base Combined Pressure output and Analog Output on working sensor only.
FAIL	Set Combined Pressure output and Analog Output to 0 in case of sensor errors.

Example: Have the Combined Pressure output and Analog Output go to zero if a sensor is malfunctioning.

Send: `@254FAIL!ZERO\`

Reply: `@253ACKZERO\`

LED Behavior (LED)

The VPM-15's LED can be programmed to work in three different ways during normal operation. See "Status LED" section for more details.

Parameter	Description
SOLID	The LED is solid green.
DYNAMIC	The LED changes color to reflect the measured pressure.

Example: Have the LED change color as a function of the measured pressure.

Send: `@254LED!DYNAMIC\`

Reply: `@253ACKDYNAMIC\`

Pressure measurement (P)

The digital pressure measurement can be accessed using the S4-Connect™ programmer or RS-232/485 serial digital interface.

Reading the full range combined pressure value:

Send: @254P?\
Reply: @ACK1.0131E+3\

Reading the Vacuum Piezo value:

Send: @254P?PZV\
Reply: @ACK2.345E+2\

Reading the MEMS Pirani pressure value:

Send: @254P?MP\
Reply: @ACK1.1230E-4\

Reading the Capacitance diaphragm pressure value:

Send: @254P?CP\
Reply: @ACK1.123E-1\

Quick data acquisitions (Q)

The quick data acquisition command provides all variable measurement data and setpoint status in one string.

Reading the quick data acquisition:

Send: @254Q?\
Reply: @ACK1.0000E-2,1.2300E-2,1.2300E-2,23.24,101

Configuration of the quick data acquisition:

Send: @254Q!PZV,PIR,CMB,SETP,TEMP\
Reply: @ACK1.0000E-2,1.2300E-2,1.2300E-2,23.24,101

Read the currently configured Q-configuration:

Send: @254Q?CONFIG\
Reply: @ACKPZ,PIR,CMB,SP,TEMP\

Parameters	Description
PZV	Piezo vacuum pressure measurement
PIR	Pirani vacuum pressure measurement
CP	Capacitance vacuum pressure measurement
CMB	Combined vacuum pressure measurement
TEMP	Temperature measurement
SP	Setpoint status

Setpoint status

The setpoint status value provides a 3-digit value, where each digit represents the status of the setpoint relay 1, 2 and 3, respectively. Each digit may be 1=Energized relay, 0=De-energized relay, X=No relay installed.

Pirani and capacitance ratio measurement (RAT)

The ratio readout provides the calculated ratio between the gas depended Pirani measurement and the none-gas depended capacitance diaphragm measurement. The ratio readout can be used to determine change of gas composition or detection of water vapor content.

$$\text{Ration} = ((\text{Pir-Cap})/\text{Cap}) \times 100$$

Reading the ratio

Send: @254RAT?\

Reply: @ACK5.67\

Temperature measurement (T)

The VPM-15 has a built-in high-resolution precision temperature sensor that provides a temperature measurement of the vacuum gas in degrees Celsius with a typical accuracy of better than ± 1 °C.

Reading the temperature:

Send: @254T?\

Reply: @ACK25.22\

Unit (U)

The VPM-15 can be configured to three different pressure units and three different temperature units. If no explicit parameter (pressure, temperature) is defined, pressure is assumed.

Pressure unit		
mbar	Pascal	torr

Temperature unit		
Celsius	Fahrenheit	Kelvin

Setting pressure unit to Pascal:

Send: @254U!PASCAL\

Reply: @ACKPASCAL\

Setting pressure unit to mbar:

Send: @254U!P,MBAR\

Reply: @ACKMBAR\

Setting temperature unit to Fahrenheit:

Send: @254U!T,FAHRENHEIT\

Reply: @ACKFAHRENHEIT\

Reading current temperature unit:

Send: @254U?T\

Reply: @ACKFAHRENHEIT\



INFORMATION: All values related to pressures like setpoint values and full-scale must be entered in the current unit for the transducer. When changing unit all setpoint values are converted to the new unit and consequently setpoint functionality will remain intact when changing unit.

Statistics (STAT)

The statistics function logs the number of operation hours and the maximum and minimum measured pressure or temperature value. If no explicit parameter (pressure, temperature) is defined, pressure is assumed.

Reading the statistics (parameter is left out, so pressure is assumed):

Send: @254STAT?\

Reply: @254ACKSTAT<cr>
MIN : 5.6104E+00<cr>
MAX : 1.0159E+03<cr>
HOURS : 37\

Reading the temperature statistics:

Send: @254STAT?T\
Reply: @254ACKSTAT<cr>
MIN : 2.345E+01<cr>
MAX : 3.123E+01<cr>
HOURS : 37\

Clearing the statistics (parameter is left out, so pressure is assumed):

Send: @254STAT!CLEAR\
Reply: @254ACKCLEAR\

Sensor blending (BL)

The combined pressure output blends the three individual sensor output to provide a smooth pressure over a wide range. The blending pressures can be user adjusted to the actual application pressure profile.

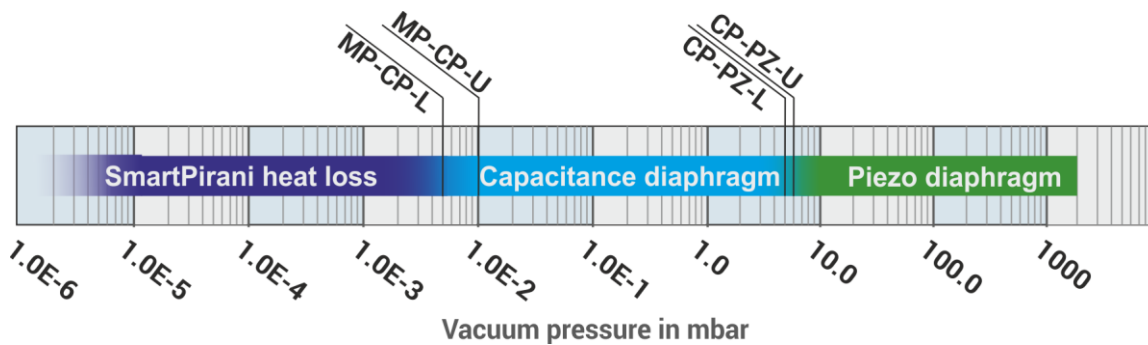

In the transition between the lower and upper blending pressure a linear weighting of the pressure is calculated.



INFORMATION: If the capacitance diaphragm zero offset is deviating or other gases than Nitrogen is present causing the MEMS Pirani to deviate from actual pressure discontinuity during the transition phase can occur.

Blend configuration command

@254BL!<BLENDTYPE>,<LOWER BLEND VALUE> ,<UPPER BLEND VALUE>\

Change MEMS Pirani and capacitance diaphragm blending pressure:

Send: @254BL!MPCP,6.0000E-03,1.0000E-02\
Reply: @254ACK MPCP - LOWER: 6.0000E-03, UPPER: 1.0000E-02\

The MEMS Pirani and capacitance diaphragm blending pressure can be set to values between 1E-3 to 1 mbar

Change capacitance diaphragm and piezo diaphragm blending pressure:

Send: @254BL!CPPZ,2.000,6.000\
Reply: @254ACK CPPZ - LOWER: 2.0000E00, UPPER: 6.0000E00\

The capacitance diaphragm and piezo diaphragm blending pressure can be set to values between 1E-1 to 7.5 mbar.

Setpoint Switch Function (Optional)

The solid-state setpoint relay function can be used for controlling and surveillance by external equipment.

The three independent solid-state switch relays can be used for external control of pumps, valves, safety interlock circuits and other external equipment. The basic control uses on/off regulation with a programmable setpoint and hysteresis value. Each solid-state relay offers both normally closed and normally open contacts. Solid-state relays are a hardware option that must be specified when ordering the transducer.

Compared to electro-mechanical relays, the solid-state relays offer superior reliability and faster switching time while providing arc free contacts and generating no EMI (electromagnetic interference) when switching contacts.

The relays are UL listed, CSA recognized, and EN/IEC 60950-1 certified for maximum confidence when used to control critical vacuum processes and high-cycle applications.

The relay switches are per default controlled by the pressure measurement but can also be configured to be controlled by the internal temperature sensor.

WARNING! Do not exceed maximum load rating of 250 mA, 50 VDC / VAC peak on relay contacts. Special precautions must be taken when driving an inductive load. Ensure that inrush peak current does not exceed relay contact ratings.

The switch can be configured to close the relay contact either above or below the setpoint value.

Above

When the switch direction is configured to above, the relay will remain energized (NO contact closed) until the hysteresis value is exceeded. Then it will change to de-energized (NC contact closed). The relay will energize (NO contact closed) again when the setpoint value is exceeded.

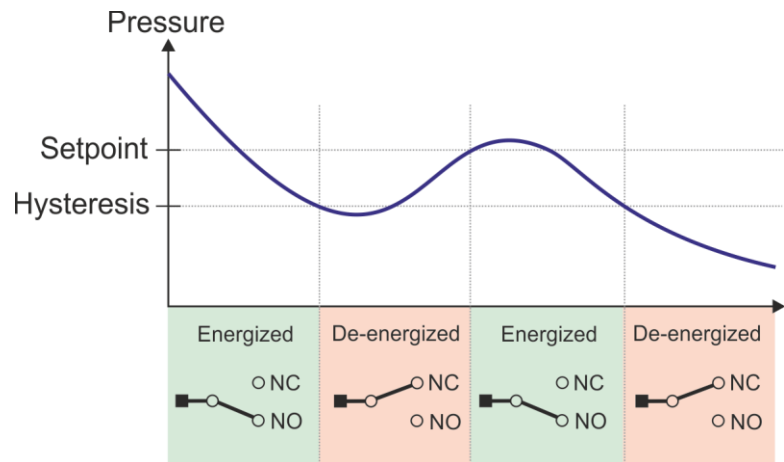

Below

When the switch direction is configured to below, the relay will remain de-energized (NC contact closed) until the hysteresis value is exceeded. Then it will change to energized (NO contact closed). The relay will de-energize (NC contact closed) again when the setpoint value is exceeded.

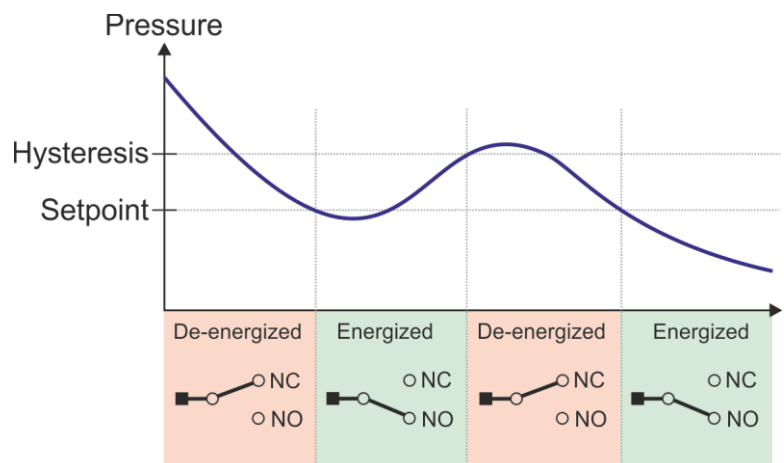

Configuration of Setpoints

Setpoints can be configured either via the S4-Connect™ software or the command protocol.



INFORMATION: All values related to pressures like setpoint values and full-scale must be entered in the current unit for the transducer. When changing unit all setpoint values are converted to the new unit and consequently setpoint functionality will remain intact when changing unit.

Command sequence example:

@254SP?\ (This step is not mandatory.) Print an overview of all setpoint settings. If no setpoints have previously been defined, a VPM-15 with three relays will produce the following overview.

```
#: ENABLE, ENERGIZED, SOURCE, DIRECTION, VALUE, HYSTERESIS<cr>
1: OFF, NO, PRES, ABOVE, +0.000E+00, +0.000E+00<cr>
2: OFF, NO, PRES, ABOVE, +0.000E+00, +0.000E+00<cr>
3: OFF, NO, PRES, ABOVE, +0.000E+00, +0.000E+00<cr>
\
```

@254SPS!1,P\
@254SPD!1,ABOVE\
Assign pressure measurement as the source for Setpoint 1. Configure the Setpoint 1 relay to be energized whenever the pressure reading is greater than the Setpoint 1 value. Whenever this value is changed, the corresponding Hysteresis value is automatically calculated to either -10% of the current setpoint value (when direction = ABOVE) or +10% of the current setpoint value (when direction = BELOW). If the temperature measurement is selected as the source, the automatically calculated Hysteresis values will be -1°C /+1°C instead of -10%/+10%.

@254SPV!1,600\
Set the value of Setpoint 1 to 600 and auto-calculate Hysteresis value. As the direction is set to ABOVE, the hysteresis value will be automatically set to 540 (the setpoint value -10%). Had the direction been BELOW, the hysteresis would have been automatically set to 660 (the setpoint value +10%).

@254SPH!1,500\
@254SPE!1,ON\
@254SPR?1\
Set the Hysteresis value for Setpoint 1 to 500. Enable Setpoint 1. Get the current status of the Setpoint 1 relay.

@254SP?\ (This step is not mandatory.) Print an overview of all setpoint settings to verify the new settings. If the unit is set to mbar and the pressure reading is above 600 – energizing the Setpoint 1 relay – the generated output would look like this:

```
#: ENABLE, ENERGIZED, SOURCE, DIRECTION, VALUE, HYSTERESIS<cr>
1: ON, YES, PRES, ABOVE, +6.000E+00, +5.000E+00<cr>
2: OFF, NO, PRES, ABOVE, +0.000E+00, +0.000E+00<cr>
3: OFF, NO, PRES, ABOVE, +0.000E+00, +0.000E+00<cr>
\
```

Command	Description	Valid input
SPD	Setpoint Direction	<SETPOINT #>, <ABOVE, BELOW>
SPE	Setpoint Enable	<SETPOINT #>, <OFF/ON>
SPH	Setpoint Hysteresis	<SETPOINT #>, <PRESSURE VALUE>
SPV	Setpoint Value	<SETPOINT #>, <PRESSURE VALUE>
SPS	Setpoint Source (pressure or temperature)	<SETPOINT #>, <P/T>
SP	Read all setpoint settings	-

Configuration of setpoint using VPM-15 configuration software

The screenshot displays the VPM-15 configuration software interface. On the left, a graph shows 'Current Reading' at 1015,38 mbar and a pressure vs. time plot. The right panel, titled 'Setpoint Status', includes a toggle for 'OFF' and 'ON', a 'Direction' dropdown set to 'Trigger On Rising Temperature ("ABOVE")', a 'Source' dropdown set to 'Pressure sensor', a 'Setpoint' input field set to 60 mbar, and a 'Hysteresis' input field set to 50 mbar. An 'Apply Settings' button is at the bottom. A smaller graph on the right illustrates the setpoint and hysteresis levels on a pressure vs. time curve. Below the main interface, the 'Temperature Transmitter' section shows the model 'PCM-1-10121111' and S/N '12345678910A'. The Sens4 logo is in the bottom right corner.

Pre-configuration of setpoint values

The VPM-15 transducer can be delivered with custom defined setpoint values. Contact Sens4 sales team for more information.

Product Information and Identification

The VPM-15 has a serial number, product part number, manufacturer identity and firmware version programmed in its internal non-volatile memory.

Serial number:

Send: @254SN?\n
Reply: @ACK191230123456;

Part number:

Send: @254PN?\n
Reply: @ACKVPM-15-123456;

Manufacturer identity:

Send: @254MF?\n
Reply: @ACKSENS4;

Firmware version:

Send: @254FV?\n
Reply: @ACK1.00;

Maintenance

Maintenance is not required in many applications during the lifecycle of this product. The calibration may shift during the life-time and re-calibration by adjusting the zero point and full-scale value can be performed by the user.

The VPM-15 can be user configured, calibrated and tested using the S4-Connect™ USB adapter or RS-232/485 interface.

Adjustment of the zero point

The VPM-15 has an active and individual temperature compensation to account for zero-point drift. In many applications, a user adjustment of the zero point is not required during the lifetime of the product.

If drift of the zero-point is observed, it can be adjusted using the S4-Connect™ USB programmer, RS-232 / RS-485 communication interface or by pressing the zero switch.

Zero-point adjustment procedure using digital interface

1. Evacuate the transducer to a vacuum pressure below 1.00E-6 mbar.
2. Send command: @254VAC!\
3. Reply: @254ACK<value>\

The reply <value> is the calculated offset pressure value as function of the factory default zero offset subtracted from the user offset adjustment.

If the recommended zero adjustment vacuum pressure cannot be achieved due to inadequate vacuum pumping capacity, the zero-point adjustment can be performed at a higher pressure by entering the actual pressure value measured by a reference transducer. Following command example will perform a zero adjustment at 5.00E-5 mbar:

1. Adjust the vacuum pressure to a known value
2. Send command: @254VAC!5.00E-5\
3. Reply: @254ACK<value>\

Zero-point adjustment procedure using the zero switch

The VPM-15 can also be zero adjusted by pressing the zero-adjustment switch using a tool with a maximum diameter of 1.5 mm.



1. Evacuate the transducer to a vacuum pressure below 1.00E-6 mbar.
2. Press the zero switch for 2 seconds
3. The LED will strobe green after completion of zero adjustment or red if the transducer is not able to perform zero adjustment.

Piezo sensor zero adjustment

The Piezo sensor is automatically zero-adjusted, whenever the pressure measured by the Pirani is lower than 1.00E-2 mbar (7.50E-3 Torr).

Capacitance diaphragm sensor zero adjustment

The capacitance diaphragm sensor is automatically zero-adjusted, whenever the pressure measured by the Pirani is lower than 1.00E-3 mbar (7.50E-4 Torr).

The capacitance diaphragm auto zero-point adjustment pressure point is programmable and can be trimmed to the actual application pressure profile and achievable base pressure.

The capacitance diaphragm auto zero adjustment feature have several safeguards to prevent wrong zero adjustment of the capacitance diaphragm gauge. The zero adjustment will only be executed when the pressure measured by the Pirani is lower than auto zero point and the pressure measured by the Pirani and Capacitance manometer is decreasing or stable within a certain level.

The capacitance diaphragm auto zero point can be adjusted (e.g. 5.67E-4 mbar) using following command:

1. Send the command: @254VAC!AUTO,5.67E-4\
2. Reply: @254ACK5.67E-4\

Adjustment of Full-scale

Piezo sensor full-scale adjustment

The piezo sensor can be full-scale adjusted using the digital interface by the following procedure:

1. Expose the transducer flange to atmospheric ambient pressure
2. Obtain the actual atmospheric pressure (e.g. 1,013.1 mbar) from a reference gauge
3. Send the command: @254FS!PZ,1013.1\
4. Reply: @254ACK<value>
\

The acknowledge value represents the scaling factor for the new piezo full-scale calibration. The full-scale adjustment can be executed in the pressure range 400-1100 mbar (300-825 Torr).

Pirani sensor full-scale adjustment

The pirani sensor can be full-scale adjusted using the digital interface by the following procedure:

1. Expose the transducer flange to a Nitrogen pressure between 1 and 20 mbar
2. Obtain the actual pressure (e.g. 11.2 mbar) from a reference gauge
3. Send the command: @254FS!MP,11.2\
4. Reply: @254ACK<value>
\

The Pirani sensor can also be full-scale adjusted by use of the internal piezo sensor as reference:

1. Expose the transducer flange to a Nitrogen pressure between 1 and 20 mbar
2. Send the command: @254FS!MP\
3. Reply: @254ACK<value>
\

Resetting to Factory Default

The Factory Default command will reset all user settings to factory default, including setpoint settings, pressure unit and user-adjustment of zero point and full-scale.

Sens4 offers pre-configuration of user parameters, and if the product is delivered with a special user configuration, the factory default command will reset to the original user configuration as delivered.

Reset to factory default:

Send: @254FD!\

Reply: @ACKFD\

Parameter	Value
Vacuum zero adjustment	0
Full scale adjustment	1
Capacitance auto-zero	1.00E-3 mbar
Unit	As delivered
Baud rate	9600
Address	253
Analog output configuration	As delivered
Setpoint direction	Above or as delivered
Setpoint enable	OFF or as delivered
Setpoint hysteresis	As delivered
Setpoint value	As delivered
Setpoint source	Pressure
Capacitance / Piezo lower blend	5.00 mbar
Capacitance / Piezo upper blend	6.00 mbar
Pirani / Capacitance lower blend	5.00E-3 mbar
Pirani / Capacitance upper blend	1.00E-2 mbar

Individual reset to factory default

It is possible to reset only certain settings to their factory default values. This is done by adding an optional argument to the FD command. If the argument is left blank, all parameters will be reset to their default values.

Send: @254FD!<ARGUMENT>\

Reply: @ACKFD\

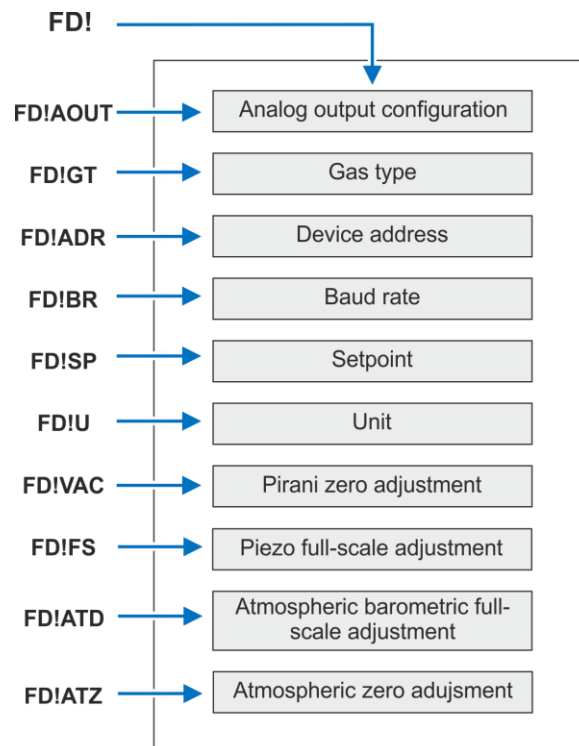

Reset to factory default using S4-Connect™ software

Go to the factory Def. tab and check the parameters to be reset and press the “Issue Factory Default” button.

The screenshot displays the S4-Connect software interface for a pressure transmitter. The main display shows a current reading of 1015,38 mbar. Below this is a line graph showing pressure over time, with the y-axis labeled 'Pressure [mbar]' ranging from 1015,2 to 1015,75 and the x-axis labeled 'Time []' ranging from 462 to 512. The graph shows a fluctuating pressure that generally decreases over time. To the right of the graph is a configuration panel with tabs for 'Analog Output', 'Relay', 'Factory Def.', and 'Advanced'. The 'Factory Def.' tab is active, showing a 'Select Items' section with the following options: 'All' (unchecked), 'Analog Output Scaling' (checked), 'Damping' (unchecked), 'Unit' (checked), 'Setpoint' (checked), 'Full-scale' (unchecked), and 'Zero Point' (unchecked). Below these options is a button labeled 'Issue Factory Default'. At the bottom of the interface, there is a section for 'Temperature Transmitter' with the model 'PCM-1-10121111' and serial number 'S/N: 12345678910A'. To the right of this text is an image of the transmitter hardware, and further right is the 'SENS4' logo.

900 Series Vacuum Transducer Compatibility

The VPM-15 offers pin, analog output and digital communication protocol compatibility with the 901P, 925 and 910 vacuum transducers from MKS Instruments.

When using the 900 series communication protocol, the communication is based on an ASCII protocol that includes a start character, device address, command or query and an end character for termination:

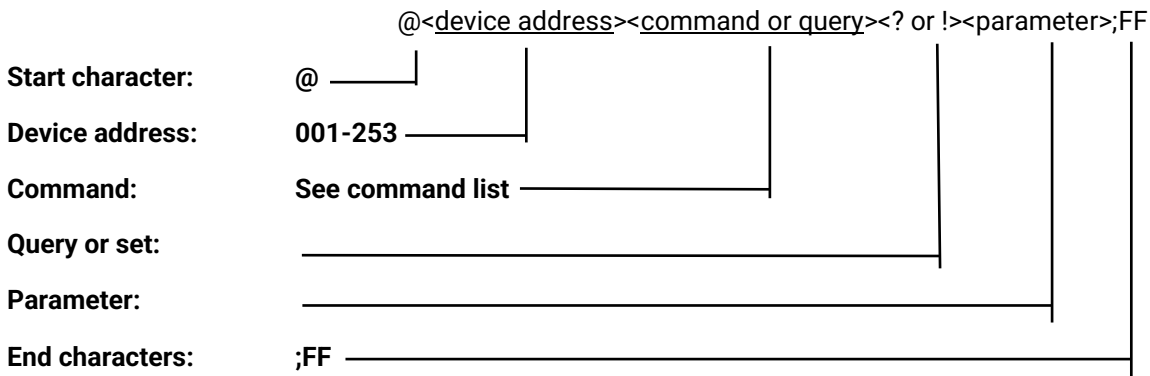

Example of how to send a command to the transducer using the 900 Series protocol

Programming a setpoint value of 1.23E-4 (using the default unit setting of the transducer, e.g. mbar):

Send: @254SP1!1.24E-4;FF
 Reply: @ACK1.23E-4;FF

The VPM-15 supports following 900 Series commands:

Command	Description	Query	Set	Valid input parameter
AD	Communication address	X	X	3 digits (range 001-253)
AO1	Analog output configuration	X	X	STD, 0-39
BR	Set baud rate	X	X	4800, 9600, 19200, 38400, 57600, 115200 (default 9600)
FD	Factory default	X	X	ADR,AOC,FS,U,SP,VAC,<NONE>
FS	Full-scale adjustment	X	X	
FV	Firmware version	X		-
GT	Gas type	X	X	Nitrogen, Helium, Argon, Air
MF	Manufacturer	X		-
MD	Model name	X		-
PR1	Pressure measurement (Pirani)	X		-
PR2	Pressure measurement (Piezo)	X		-
PR3	Pressure measurement (Combined)	X		-
PN	Part number	X		-
SP1	Setpoint 1 value	X	X	<PRESSURE VALUE>
SD1	Setpoint 1 direction	X	X	ABOVE, BELOW
EN1	Setpoint 1 enable	X	X	OFF, ON
SH1	Setpoint 1 hysteresis	X	X	<PRESSURE VALUE>
SP2	Setpoint 2 value	X	X	<PRESSURE VALUE>
SD2	Setpoint 2 direction	X	X	ABOVE, BELOW
EN2	Setpoint 2 enable	X	X	OFF, ON
SH2	Setpoint 2 hysteresis	X	X	<PRESSURE VALUE>
SP3	Setpoint 3 value	X	X	<PRESSURE VALUE>
SD3	Setpoint 3 direction	X	X	ABOVE, BELOW
EN3	Setpoint 3 enable	X	X	OFF, ON
SH3	Setpoint 3 hysteresis	X	X	<PRESSURE VALUE>
SN	Serial number	X		-
TEM	Sensor temperature	X		-
U	Pressure unit	X	X	MBAR, PASCAL, TORR
VAC	Pirani Zero adjustment	X	X	No input or <PRESSURE VALUE>

Return

Before returning a product to Sens4 proper return forms and a return materials authorization (RMA) must be filled out. The RMA procedure can be found on: www.sens4.com/support



INFORMATION: Sens4 does not accept return of products without return materials authorization. Sens4 does not accept any return of products that have been exposed to or contaminated with radioactive, chemical, biological or other harmful or dangerous substances.

RMA – Return Material Authorization

This form should be filled out and enclosed with the package
Please contact Sens4 to obtain RMA # email: support@sens4.com



Sens4 A/S
Ndr. Strandvej 119G
3150 Hellebaek
Denmark

RMA#: _____ Date: _____

Company name _____

Address: _____

Contact name: _____

Phone: _____

Email: _____

Part number: _____ Serial number: _____

Reason for the return:

Warranty Repair	Chargeable Repair	Exchange	Loan	Demo	Other	<i>If other, please list:</i>
<input type="checkbox"/>	<input type="checkbox"/>	<input type="checkbox"/>	<input type="checkbox"/>	<input type="checkbox"/>	<input type="checkbox"/>	_____

Has the product been contaminated with or exposed to the following?

	No	Yes	
Biological hazard	<input type="checkbox"/>	<input type="checkbox"/>	<i>If other, please list:</i>
Radioactivity	<input type="checkbox"/>	<input type="checkbox"/>	
Toxic gases or materials	<input type="checkbox"/>	<input type="checkbox"/>	
Other harmful substances	<input type="checkbox"/>	<input type="checkbox"/>	



If "yes" has been answered to any of the above questions please note that **Sens4 does not accept any return of products that have been exposed to or contaminated with radioactive, chemical, biological and other harmful or dangerous substances.**

For questions regarding our return policy please contact email: support@sens4.com

If the product is being returned for service repair, please describe failure mode and application:

Application: _____

Failure mode: _____

I, the undersigned, hereby acknowledge that the information provided on this form is legally binding and declare that the information supplied is accurate and adequate to judge any harmful contamination.

Date

Name

Signature

Specifications

Specifications	
Measuring range in mbar	1×10 ⁻⁶ to 1333 mbar (7.5×10 ⁻⁷ to 1000 Torr)
Measuring principle 1×10 ⁻⁶ to 4.99×10 ⁻³ mbar	MEMS Pirani thermal conductivity
Measuring principle 5×10 ⁻³ to 1.00×10 ⁻² mbar	Blended MEMS Pirani / CDG reading
Measuring principle 1.0×10 ⁻² to 4.99 mbar	Capacitance diaphragm gauge (CDG)
Measuring principle 5 to 6 mbar	Blended MEMS Piezo / CDG
Measuring principle 6 to 1333 mbar	MEMS piezo resistive diaphragm
Accuracy ⁽⁹⁾ 1×10 ⁻⁵ to 9.99×10 ⁻⁵ mbar	25% of reading
Accuracy ⁽⁹⁾ 1×10 ⁻⁴ to 9.99×10 ⁻³ mbar	5% of reading
Accuracy ⁽⁹⁾ 1×10 ⁻² to 800 mbar	0.5% of reading
Accuracy ⁽⁹⁾ 800 to 1099 mbar	0.25% of reading
Accuracy ⁽⁹⁾ 1100 to 1333 mbar	0.5% of reading
Vacuum temperature sensor range	-20 to +85 °C
Analog output resolution	16 bit (150 µV)
Analog output update rate	124 Hz
Response time (ISO 19685:2017)	<20 ms
Temperature compensation	+10 to +50 °C
Temperature measurement range	-40 to +80 °C
Temperature measurement absolute accuracy	±1.5 °C (0 to +80 °C)
Solid state relay set point range	5×10 ⁻⁶ to 1333 mbar (3.75×10 ⁻⁶ to 1000Torr)
Solid state relay contact rating	50 V, 100 mA _{rms} / mA _{DC}
Solid state relay contact on resistance	<35 Ω
Solid state relay contact endurance	Unlimited (no mechanical wear)
Solid state relay approvals	UL Recognized: File E76270 CSA Certified: Certificate 1175739 EN/IEC 60950-1 Certified
Environment conditions	
Operating ambient temperature	-20 to +50 °C
Media temperature	-20 to +50 °C
Storage ambient temperature	-40 to +80 °C
Bake-out temperature (non-operating)	+80 °C
Maximum media pressure	4 bar absolute ⁽¹⁰⁾
Mounting position	Arbitrary
Protection rating, EN 60529/A2:2013	IP40
Humidity, IEC 68-2-38	98%, non-condensing
Power supply	
Supply voltage	12-30 VDC
Power consumption	350 mW (max)
Reverse polarity protection	Yes
Overvoltage protection	Yes
Internal fuse	100 mA (thermal recoverable)

(9) Accuracy and repeatability specifications are typical values measured at ambient temperature in Nitrogen atmosphere after zero adjustment.

(10) Refer also to maximum pressure rating for the used fittings. Exceeding maximum pressure will cause permanent damage to the capacitance diaphragm sensor.

Materials	
Enclosure	SS 1.4401 / AISI 316 / Aluminium 6061
Vacuum flange (media wetted)	SS 1.4401 / AISI 316
Vacuum exposed materials (media wetted) Standard version	316 Stainless steel, Kovar, glass, silicon, nickel, aluminium, SiO ₂ , Si ₃ N ₄ , Al ₂ O ₃ , gold, Viton [®] , low out-gassing epoxy resin, solder, RO4305, vitreous silica, Aluminum oxide ceramic (Al ₂ O ₃)
Vacuum exposed materials (media wetted) Parylene protected version	316 Stainless steel, Viton [®] , Parylene
Vacuum exposed materials (media wetted) Ceramic protected version	316 Stainless steel, Viton [®] , Aluminum oxide ceramic (Al ₂ O ₃)
Process leak tightness	<1·10 ⁻⁹ mbar-l/s
Enclosure	AISI 316 / Aluminium 6061
Approvals	
CE	EMC directive 2014/30/EU
RoHS compliance	Directive EN 63000:2018
REACH compliance	Directive 1907/2006/CE

Accessories

S4-Connect™

USB programmer for transmitters and transducers



Part number	Description
PRG-S4-15DS-01	S4-Connect programmer USB, 15p HD D-sub connector
PRG-S4-9DS-01	S4-Connect programmer USB, 9p D-sub connector
PRG-S4-RJ45-01	S4-Connect programmer USB, 8p FCC68/RJ45
PRG-S4-HM-01	S4-Connect programmer USB, 6p Hirschmann

RS232 / RS485 interface

USB-to-Serial converter for VPM-15 SmartPirani transducers

Part number	Description
PRG-RS2-15DS-01	RS232 communicator USB, 15p HD D-sub connector
PRG-RS4-15DS-01	RS485 communicator USB, 15p HD D-sub connector
PRG-RS2-9DS-01	RS232 communicator USB, 9p D-sub connector
PRG-RS4-9DS-01	RS485 communicator USB, 9p D-sub connector

Cables

Part number	Description
CAB-F15DSM15DS-003	15 p HD D-sub female to 15 p D-sub male with 3 m cable
CAB-F15DSM15DS-005	15 p HD D-sub female to 15 p D-sub male with 5 m cable
CAB-F15DSM15DS-010	15 p HD D-sub female to 15 p D-sub male with 10 m cable
CAB-F15DSM15DS-003	9 p D-sub female to 15 p D-sub male with 3 m cable
CAB-F15DSM15DS-005	9 p D-sub female to 15 p D-sub male with 5 m cable
CAB-F15DSM15DS-010	9 p D-sub female to 15 p D-sub male with 10 m cable

Declaration of Conformity

This declaration of conformity has been made in accordance with EN ISO/IEC 17050-1:2010

Manufacturer: Sens4 A/S
Address: Nordre Strandvej 119G
3150 Hellebaek
Denmark

We hereby declare under our sole responsibility that the following products:

Product description: Vacuum Pressure Transducer
Product part number: VPM-15-xxxxxxx

Complies with the requirements of following relevant European Union harmonization directive:

Electromagnetic Compatibility (EMC) Directive 2014/30/EU
RoHS Directive EU 2015/863

Conformity is assessed in accordance to the following standards:

Reference: Date	Title
EN 61326-1:2021	Product family standard, Measurement, control and laboratory equipment
EN 61326-2-3:2021	Test configuration, operational conditions and performance criteria for transducers with integrated or remote signal conditioning
EN 61000-3-2:2006 + A1:2009 and A2:2009	Limits for harmonic current emissions
EN 61000-3-3:2008	Limitation of voltage changes, voltage fluctuations and flicker in public low-voltage supply systems
EN 63000:2018	Technical documentation for the assessment of electrical and electronic products with respect to the restriction of hazardous substances

Signed on behalf of: Sens4 A/S
Place of issue: Hellebaek, Denmark
Date of issue: August 2nd 2021
Signature:



Name, Title _____
Ole Wenzel, Chief Executive Officer

Contact and support

This product has been engineered and made in Denmark by:

Sens4 A/S
Nordre Strandvej 119G
3150 Hellebaek
Denmark

Phone: +45 88447044
Email: support@sens4.com

Website: www.sens4.com

Other Vacuum Measurement Products

The Sens4 vacuum transducer product range offers the market's most advanced multi-sensor transducers for use in a wide selection of industrial and scientific vacuum applications.



TrueVac™ Controller

The TrueVAC™ Vacuum Controller is an advanced, versatile instrument designed for precise monitoring and control of vacuum systems across a wide range of industrial and scientific applications. With its high-resolution digital display and intuitive interface, TrueVAC offers real-time vacuum measurement and control, allowing users to efficiently manage processes and maintain optimal conditions.

VPM-17 TriCAP™ ATM Transducer

The VPM-17 TriCAP™ ATM transducer is pin and output compatible with the VPM-15. The VPM-17 has an additional barometric pressure measurement capability that enable accurate measurement relative to ambient pressure.

For demanding applications, the VPM-17 TriCAP™ ATM is available with corrosion resistant ceramic or Parylene coated sensors.



VPM-7 for Load-lock Control

The VPM-7 SmartPirani™ ATM is designed for load-lock pressure control and enable accurate control of vacuum system venting. It provides flexible interface and several control options including high-resolution analog output with emulation curves for other vendors vacuum gauges, 3 independent solid-state relays and digital RS-232 or RS-485 interface.

For more information visit:

www.sens4.com



Our passion | Your value™